

HATSAN AIRGUNS



HATSAN.COM.TR



Serious. Solid. Impact

THE HATSAN DIFFERENCE



More Power

Even though velocity rates may appear the same from brand to brand, in most instances that is not the case. Hatsan establishes its velocity rating using heavier lead pellets, while most competitors use lighter aluminum pellets to market their velocities. What this means for you is that a Hatsan airgun delivers **OVER 30% MORE IMPACT ENERGY** than an alloy-tested airgun with the same velocity.



Unique Features

Many of our airguns offer specialty features that come standard within our product line to provide shooters with a better experience, including the Quattro Trigger, SAS-Shock Absorber System, QuietEnergy, XRS – Recoil Reduction System, Barrel Release System, TruGlo® fiber optics, the Triopad® butt system, patented “Antidouble pellet feed mechanism” preventing more than one pellet loading into barrel and “anti-knock system” preventing gas wastage when rifle is knocked or bounced.

What sets Hatsan Airguns apart from The Competition?



Custom Designs

While other manufacturers work from widely used templates, all Hatsan designs are conceived and developed in-house. This means your Hatsan airgun is an original, not a reproduction.



100% Vertically Integrated

Complete vertical integration ensures the high quality you expect from Hatsan. Every part of every airgun is produced right in our facilities to guarantee a wellmade finished product. And only the highest-grade raw materials are used, including fine Turkish walnut and durable German steel.

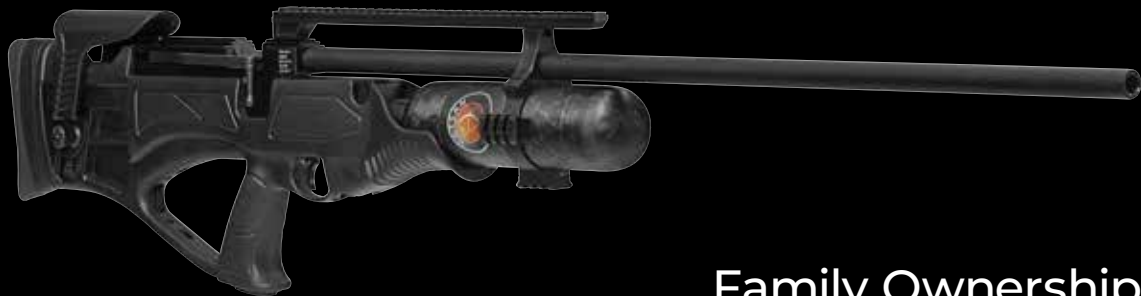

Family Ownership

It all started in 1976 with one young man hoping to replicate an air dart gun in his parents' garage. Since that time, Hatsan has become one of the world's most recognized brands in the shooting sports, airgun and firearm industry – delivering its products to more than 95 countries. This family owned and operated manufacturer maintains a hands - on approach - producing all designs and components in - house to ensure that each product deserves to bear the Hatsan name. In fact, the original founder is still very involved in new product development and design.



Serious. Solid. Impact

BLITZ

Full-Auto

72joulesPOWER!



Full-Auto and Semi-Auto firing mode pre-charged pneumatic (PCP) air rifle. Selectable firing mode switch. Patented efficient air-operated system.

- Elevation and fit angle & adjustable rubber butt pad.
- Tactical style ambidextrous stock with thumbhole
- Elevation adjustable cheek rest.
- Elevation & windage adjustable fiber optic rear sight built into the carry handle.



Select Fire Switch. Choose between Semi & Full Auto.



21-shot magazine in .22 (5.5mm), 19-shot magazine in .25 (6.35mm) and 16-shot magazine in .30 (7.62mm) caliber



Serious. Solid. Impact

FULL AUTO & SemiAutoAction

**FULLY SHROUDED
BARREL**

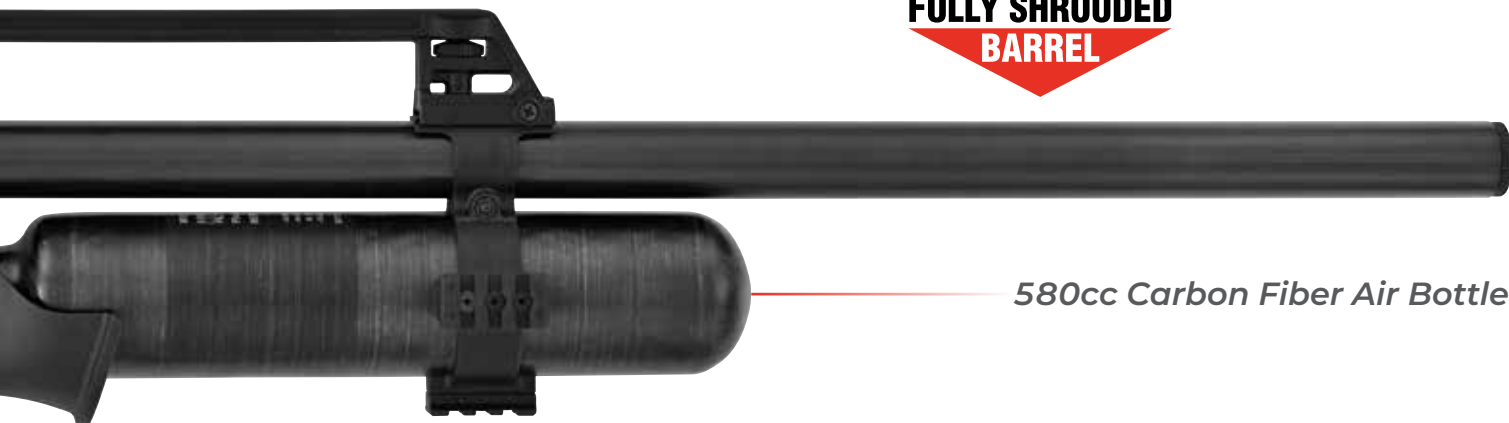

580cc Carbon Fiber Air Bottle



BLITZ FDE

Flat Dark Earth Color Stock version.



FULL AUTO & SemiAutoAction

| Model | Blitz | | | |
|--|---|-----------------|-----------------|------|
| Caliber | 5.5mm / .22cal | 6.35mm / .25cal | 7.62mm / .30cal | |
| Max. Muzzle Velocity (*) | 320m/s(1050fps) | 295m/s(970fps) | 221m/s(730fps) | |
| Energy (*) | Joules | 49 | 56 | 71.8 |
| | ft.lbsv | 36 | 41 | 53 |
| Magazine Capacity | 21 | 19 | 16 | |
| Air Tube Volume | 580cc | | | |
| Fill Pressure | 250 BAR | | | |
| Number of Semi Auto or Full Auto Shots at Optimal Velocity | 130 | 110 | 100 | |
| Stock | Tactical Synthetic Stock. Ergonomic Pistol Grip. Elevation adjustable Cheek-Rest. | | | |
| Overall Length | 1150mm (45.2") | | | |
| Barrel Length | 585mm (23") | | | |
| Weight | 4kg (8.8lbs) | | | |

Adjustable rear sight built into the carrying handle & adjustable front sight.



* Velocity results may vary as much as 20% due to pellet weight, pellet shape, temperature, elevation, as well as other factors.

** Minimum 100 bar pressure necessary for full auto or semi auto action.



Serious. Solid. Impact

1155fps POWER!
with Lead Pellets

BLITZ BP

Full-Auto

FULL AUTO & SemiAuto Action

**FULLY SHROUDED
BARREL**



580cc Carbon Fiber Air Bottle

- Elevation and fit angle & adjustable rubber butt pad
- Elevation adjustable cheek rest



Select Fire Switch Choose Between Semi- & Full Auto

Pistol Grip can be set to different locations for small; medium or big fingers. Finger distance to the trigger shoe can be adjusted by 15 mm.



21-shot magazine in .22 (5.5mm), 19-shot magazine in .25 (6.35mm) and 16-shot magazine in .30 (7.62mm) caliber



| Model | | Hatsan Blitz BP | | | |
|-------------------------------------|---------|--|------------------|-----------------|------------------|
| Caliber | | 4.5mm / .177cal | 5.5mm / .22cal | 6.35mm / .25cal | 7.62mm / .30 cal |
| Max. Muzzle Velocity (*) | | 350m/s (1155fps) | 320m/s (1050fps) | 295m/s (970fps) | 221m/s (730fps) |
| Energy (*) | Joules | 34,7 | 49 | 56 | 71,8 |
| | ft. lbs | 25,5 | 36 | 41 | 53 |
| Magazine Capacity | | 24 | 21 | 19 | 16 |
| Air Tube Volume | | 580cc (carbon fiber)+30cc | | | |
| Fill Pressure | | 250 BAR | | | |
| Number of Shots at Optimal Velocity | | 140 | 130 | 110 | 100 |
| Stock | | Bullpup, advanced polymer, elevation adjustable comb, adjustable but pad | | | |
| Overall Length | | 905mm (35.6") | | | |
| Barrel Length | | 585mm (23") | | | |
| Weight | | 4kg (8.8lbs) | | | |

* Velocity results may vary as much as 20% due to pellet weight, pellet shape, temperature, elevation, as well as other factors.

** Minimum 100 bar pressure necessary for full auto or semi auto action.

1155fps POWER!
with Lead Pellets



Serious. Solid. Impact

BLITZ MEVZI

Full-Auto II; III; IV

**FULLY SHROUDED
BARREL**

FULL AUTO & SemiAutoAction

**BLITZ
MEVZI IV**



| Model | | Hatsan Blitz Mevzi 4 | | | |
|-------------------------------------|--------|--|-----------------|-----------------|------------------|
| Caliber | | 4.5mm / .177cal | 5.5mm / .22cal | 6.35mm / .25cal | 7.62mm / .30 cal |
| Max. Muzzle Velocity (*) | | 350m/s(1155fps) | 320m/s(1050fps) | 295m/s(970fps) | 221m/s(730fps) |
| Energy (*) | Joules | 34,7 | 49 | 56 | 71,8 |
| | ft.lbs | 25,5 | 36 | 41 | 53 |
| Magazine Capacity | | 24 | 21 | 19 | 16 |
| Air Tube Volume | | 580cc x 4 pcs (carbon fiber) | | | |
| Fill Pressure | | 250 BAR | | | |
| Number of Shots at Optimal Velocity | | 500 | 480 | 400 | 360 |
| Stock | | Tactical Synthetic Stock, Ergonomic Pistol Grip. Adjustable Cheek Piece. | | | |
| Overall Length | | 905mm (35.6") | | | |
| Barrel Length | | 585mm (23") | | | |
| Weight | | 6.15 kg (13.5 lbs) | | | |

Full-Auto and Semi-Auto firing mode pre-charged pneumatic (PCP) air rifle. Selectable firing mode switch. Patented efficient air-operated system. 580cc carbon fiber air bottle mounted in the forearm. BLITZ MEVZI II Comes with two 580 cc carbom fiber air bottle. BLITZ MEVZI III Comes with three 580 cc carbom fiber air bottle. BLITZ MEVZI IV Comes with four 580 cc carbom fiber air bottle. Patented anti-knock system to prevent discharge of the rifle when rifle is knocked or bounced.

FULL AUTO & SemiAutoAction

FULL AUTO & SemiAutoAction

**BLITZ
MEVZI II**



**BLITZ
MEVZI III**



| Model | | Hatsan Blitz Mevzi 2 | | | |
|-------------------------------------|--------|--|-----------------|-----------------|------------------|
| Caliber | | 4.5mm / .177cal | 5.5mm / .22cal | 6.35mm / .25cal | 7.62mm / .30 cal |
| Max. Muzzle Velocity (*) | | 350m/s(1155fps) | 320m/s(1050fps) | 295m/s(970fps) | 221m/s(730fps) |
| Energy (*) | Joules | 34,7 | 49 | 56 | 71,8 |
| | ft.lbs | 25,5 | 36 | 41 | 53 |
| Magazine Capacity | | 24 | 21 | 19 | 16 |
| Air Tube Volume | | 580cc x 2 pcs (carbon fiber) | | | |
| Fill Pressure | | 250 BAR | | | |
| Number of Shots at Optimal Velocity | | 265 | 250 | 210 | 190 |
| Stock | | Tactical Synthetic Stock, Ergonomic Pistol Grip. Adjustable Cheek Piece. | | | |
| Overall Length | | 905mm (35.6") | | | |
| Barrel Length | | 585mm (23") | | | |
| Weight | | 4.7 kg (10.4 lbs) | | | |

| Model | | Hatsan Blitz Mevzi 3 | | | |
|-------------------------------------|--------|--|-----------------|-----------------|------------------|
| Caliber | | 4.5mm / .177cal | 5.5mm / .22cal | 6.35mm / .25cal | 7.62mm / .30 cal |
| Max. Muzzle Velocity (*) | | 350m/s(1155fps) | 320m/s(1050fps) | 295m/s(970fps) | 221m/s(730fps) |
| Energy (*) | Joules | 34,7 | 49 | 56 | 71,8 |
| | ft.lbs | 25,5 | 36 | 41 | 53 |
| Magazine Capacity | | 24 | 21 | 19 | 16 |
| Air Tube Volume | | 580cc x 3 pcs (carbon fiber) | | | |
| Fill Pressure | | 250 BAR | | | |
| Number of Shots at Optimal Velocity | | 375 | 360 | 300 | 270 |
| Stock | | Tactical Synthetic Stock, Ergonomic Pistol Grip. Adjustable Cheek Piece. | | | |
| Overall Length | | 905mm (35.6") | | | |
| Barrel Length | | 585mm (23") | | | |
| Weight | | 5.4 kg (11.9 lbs) | | | |

* Velocity results may vary as much as 20% due to pellet weight, pellet shape, temperature, elevation, as well as other factors.
** Minimum 100 bar pressure necessary for full auto or semi auto action.

GALATIAN 5 AUTO

Semi Auto

**FULLY SHROUDED
BARREL**

SemiAutoAction



Semi auto action, pre-charged pneumatic (PCP) air rifle. Checkering on grip & forend for better control & feel. Detachable aluminum air cylinder tube (255cc). Spare cylinders are available. Patented anti-knock system to prevent gas wastage when rifle is knocked or bounced. Gold plated metal trigger & synthetic trigger guard.



Sights are easily detachable which allows to mount optics on the receiver.



(*) Scope sold separately

| Model | | Galatian 5 Auto | | |
|---|-------------|-----------------------------|-----------------|-----------------|
| Caliber | | 4.5mm / .177cal | 5.5mm / .22cal | 6.35mm / .25cal |
| Max. Muzzle Velocity (*) | | 310m/s (1020fps) | 288m/s (950fps) | 265m/s (870fps) |
| Energy (*) | Joules | 27 | 39,8 | 45 |
| | ft. lbs | 20 | 29 | 33,5 |
| Magazine Capacity | | 14 | 12 | 10 |
| Air Tube Volume | | 255cc | | |
| Fill Pressure | | 200 BAR | | |
| Number of Semi Automatic Shots at Optimal Velocity (**) | | 50 | | |
| Stock | | High Quality Turkish Walnut | | |
| Overall Length | | 1068mm (42") | | |
| Barrel Length | | 500mm (19.7") | | |
| Weight | | 3.7kg (8.1lbs) | | |
| Fiber Optic Sights Diameters | Rear Sight | 0.9mm (.035") green | | |
| | Front Sight | 1.5mm (.060") red | | |



Carrying case included.

* Velocity results may vary as much as 20% due to pellet weight, pellet shape, temperature, elevation, as well as other factors.

** Minimum 100 bar pressure necessary for semi auto action.

1020fps POWER!
with Lead Pellets



GALATIAN 6 AUTO

Semi Auto

**FULLY SHROUDED
BARREL**

SemiAutoAction



Semi auto action, pre-charged pneumatic (PCP) air rifle. Detachable aluminum air cylinder tube (255cc). Spare cylinders are available. Includes quick-fill nozzle & air cylinder discharging cap. Patented anti-knock system to prevent gas wastage when rifle is knocked or bounced. Black metal trigger & synthetic trigger guard.



Sights are easily detachable which allows to mount optics on the receiver.

SemiAutoAction



**GALATIAN
TACT AUTO**

Tactical telescopic stock version.
Comes with a foregrip bipod.

Carrying case included.

| Model | Galatian 6 Auto | | |
|--|------------------|---------------------|-----------------|
| Caliber | 4.5mm / .177cal | 5.5mm / .22cal | 6.35mm / .25cal |
| Max. Muzzle Velocity (*) | 310m/s (1020fps) | 288m/s (950fps) | 265m/s (870fps) |
| Energy (*) | Joules | 27 | 39,8 |
| | ft.lbs | 20 | 29 |
| Magazine Capacity | 14 | 12 | 10 |
| Air Tube Volume | 255cc | | |
| Fill Pressure | 200 BAR | | |
| Number of Semi Automatic Shots at Optimal Velocity | 50 | | |
| Stock | Advanced Polymer | | |
| Overall Length | 1068mm (42") | | |
| Barrel Length | 500mm (19.7") | | |
| Weight | 3.85kg (8,5lbs) | | |
| Fiber Optic Sights Diameters | Rear Sight | 0.9mm (.035") green | |
| | Front Sight | 1.5mm (.060") red | |

* Velocity results may vary as much as 20% due to pellet weight, pellet shape, temperature, elevation, as well as other factors.

** Minimum 100 bar pressure necessary for semi auto action.

- Telescopic stock. Can be shortened / extended by 10cm (4").
- Stock can be removed easily and you can use it with pistol grip only.
- Elevation adjustable comb.





Serious. Solid. Impact

1050fps POWER!
with Lead Pellets

BARRAGE

Semi Auto

**FULLY SHROUDED
BARREL**

SemiAutoAction



**BARRAGE
W**
Wooden Stock version

- Removable rear and front sight
- 2 spare magazine carrying slots in the stock
- Elevation adjustable comb.
- Adjustable rubber butt pad for length of pull as well as elevation and fit angle.



Carrying case included.

Semi auto action, pre-charged pneumatic (PCP) air rifle. 500cc volume air bottle mounted in the forearm. Patented anti-knock system to prevent discharge of the rifle when rifle is knocked or bounced.



BARRAGE OD
OD Green Stock version.



BARRAGE DZ
DZ Color Stock version.



**BARRAGE
FDE**
Flat Dark Earth Color Stock version.



BARRAGE M1
M1 Camo Stock version.



BARRAGE M2
M2 Camo Stock version.

| Model | Barrage | | |
|---|---|---------------------|-----------------|
| Caliber | 4.5mm / .177cal | 5.5mm / .22cal | 6.35mm / .25cal |
| Max. Muzzle Velocity (*) | 320m/s (1050fps) | 295m/s (970fps) | 270m/s (900fps) |
| Energy (*) | Joules | 27 | 42 |
| | ft.lbs | 21 | 31 |
| Magazine Capacity | 14 | 12 | 10 |
| Air Tube Volume | 500cc | | |
| Fill Pressure | 250 BAR | | |
| Number of Semi Automatic Shots at Optimal Velocity (**) | 100 | 120 | 120 |
| Stock | Advanced polymer, thumbhole, elevation adjustable comb, adjustable butt pad | | |
| Overall Length | 1040mm (40.9") | | |
| Barrel Length | 500mm (19.7") | | |
| Weight | 4.62kg (10.1lbs) | | |
| Fiber Optic Sights Diameters | Rear Sight | 0.9mm (.035") green | |
| | Front Sight | 1.5mm (.060") red | |

* Velocity results may vary as much as 20% due to pellet weight, pellet shape, temperature, elevation, as well as other factors.

** Minimum 100 bar pressure necessary for semi auto action.

1050fpsPOWER!
with Lead Pellets



Serious. Solid. Impact

BULLMASTER

Semi Auto

SemiAutoAction

**FULLY SHROUDED
BARREL**



BULLMASTER FDE
Flat Dark Earth Color Stock version.

BULLMASTER OD
OD Green Stock version.

BULLMASTER DZ
DZ Color Stock version.

Genuine bullpup design, Semi auto action pre-charged pneumatic (PCP) air rifle. 500cc volume air bottle mounted in the forearm. Patented anti-knock system to prevent discharge of the rifle when rifle is knocked or bounced.

| Model | BullMaster | | | |
|--|--|-------------------|-----------------|------|
| Caliber | 4.5mm / .177cal | 5.5mm / .22cal | 6.35mm / .25cal | |
| Max. Muzzle Velocity (*) | 320m/s (1050fps) | 295 m/s (970 fps) | 270m/s (900fps) | |
| Energy (*) | Joules | 27 | 42 | 48,5 |
| | ft.lbs | 21 | 31 | 36 |
| Magazine Capacity | 14 | 12 | 10 | |
| Air Tube Volume | 500+30cc | 500+30cc | 500+30cc | |
| Fill Pressure | 250 BAR | 250 BAR | 200 BAR | |
| Number of Semi Automatic Shots at Optimal Velocity (**) | 100 | 120 | 120 | |
| Stock | Bullpup, advanced polymer, thumbhole, elevation adjustable combo, adjustable but pad | | | |
| Overall Length | 785mm (30.9") | | | |
| Barrel Length | 500mm (19.7") | | | |
| Weight | 4.7kg (10.3lbs) | | | |

* Velocity results may vary as much as 20% due to pellet weight, pellet shape, temperature, elevation, as well as other factors.

** Minimum 100 bar pressure necessary for semi auto action.

INVADER AUTO

Semi-Auto

SemiAutoAction



**FULLY SHROUDED
BARREL**



INVADER AUTO OD
OD Green Color Stock version.



INVADER AUTO FDE
Flat Dark Earth Color Stock version.

| Model | Invader Auto | | |
|--|--|-----------------|-----------------|
| Caliber | 4.5mm / .177cal | 5.5mm / .22cal | 6.35mm / .25cal |
| Max. Muzzle Velocity (*) | 310m/s (1020fps) | 288m/s (950fps) | 265m/s (870fps) |
| Energy (*) | Joules | 27 | 39,8 |
| | ft.lbs | 20 | 29 |
| Magazine Capacity | 14 | 12 | 10 |
| Air Tube Volume | 255cc | | |
| Fill Pressure | 200 BAR | | |
| Number of Semi Automatic Shots at Optimal Velocity | 50 | 50 | 50 |
| Stock | Tactical Synthetic Stock Ergonomic Pistol Grip Adjustable Cheek Rest | | |
| Overall Length | 1030 mm (40.5") | | |
| Barrel Length | 500mm (19.7") | | |
| Weight | 3.7kg (8.2lbs) | | |

* Velocity results may vary as much as 20% due to pellet weight, pellet shape, temperature, elevation, as well as other factors.

** Minimum 100 bar pressure necessary for semi auto action.

800fps POWER!
with Lead Pellets



Serious. Solid. Impact

SORTIE

Semi Auto



Tactical side folding stock is included.

| Model | | Sortie | | |
|---|---------------|---|-------------------|-----------------|
| Caliber | | 4.5mm / .177cal | 5.5mm / .22cal | 6.35mm / .25cal |
| Max. Muzzle Velocity (*) | | 245m/s (800fps) | 215 m/s (700 fps) | 200m/s (660fps) |
| Energy (*) | Joules | 16,5 | 21,5 | 26 |
| | ft.lbs | 12 | 16 | 19 |
| Magazine Capacity | | 14 | 12 | 10 |
| Air Tube Volume | | 62cc | 62cc | 62cc |
| Fill Pressure | | 200 BAR | 200 BAR | 200 BAR |
| Number of Semi Automatic Shots at Optimal Velocity (**) | | 28 | 36 | 30 |
| Stock | | Ergonomic design synthetic grip with checkering Collapsible and removable butt | | |
| Overall Length | Butt Folded | 460mm (18.1") | | |
| | Butt Extended | 635mm (25") | | |
| Barrel Length | | 200mm (7.9") | | |
| Weight | | 2.16kg (4.7lbs) | | |
| Fiber Optic Sights Diameters | Rear Sight | 0.9mm (.035") green | | |
| | Front Sight | 1.5mm (.060") red | | |

* Velocity results may vary as much as 20% due to pellet weight, pellet shape, temperature, elevation, as well as other factors.

** Minimum 100 bar pressure necessary for semi auto action.

Semi auto action, pre-charged pneumatic (PCP) air rifle. 62cc volume air bottle mounted in the forearm. Patented anti-knock system to prevent discharge of the rifle when rifle is knocked or bounced. Black metal trigger.



FACTO

Butt-pad height adjustment
(up & down): 35mm
(1.38")

6-position telescopic stock and conveniently adjustable integrated cheek rest for both cheek riser height and length-of-pull rest.
(up & down); 45mm (1.79")- (back) : 40mm (1.59")

Ergonomic and reversible cocking lever for ambidextrous operation

Combo scope rail; (11mm and 22mm)



Externally adjustable hammer preload

100cc pre-airchamber

Manual safety button

QD sling swivel

Butt-pad tilt adjustment

Ergonomic soft rubber pistol grip

2-Stage fully adjustable Quattro Trigger

Rubber butt-pad offers positive shoulder purchase to prevent slippage for optimal accuracy.

Adjustable length of pull; 40mm (1.59")

R SNIPER



FACTOR SNIPER L



**FULLY SHROUDED
BARREL**



| Model | Hatsan Factor Sniper L | | | | | | | |
|-------------------------------------|---|-----------|-----------------------------------|-----------|----------------------------------|-----------|-------------------------------|-------------|
| Caliber | 5.5mm / .22cal | | 6.35mm / .25cal | | 7.62mm / .30cal | | 9mm / .35cal | |
| Max. Muzzle Velocity (*) | 318m/s (1050fps) | | 325m/s (1075fps) | | 285m/s 940(fps) | | 293m/s 970(fps) | |
| Energy (*) | Joules | 40gr slug | Joules | 45gr slug | Joules | 80gr slug | Joules | 81gr pellet |
| | ft. lbs | | up to 133 | | up to 156 | | up to 213 | |
| | up to 98 | | up to 115 | | up to 157 | | up to 169 | |
| Magazine Capacity | 21-45 | | 19-39 | | 16-33 | | 13 | |
| Air Tube Volume | 700cc (carbon fiber) | | | | | | | |
| Fill Pressure | 300 BAR | | | | | | | |
| Number of Shots at Optimal Velocity | 100 (22 gr.pellet at 1100 fps) | | 80 (33.95 gr. at pellet 1000 fps) | | 70 (46,3 gr. at pellet 1000 fps) | | 70 (81 gr. at pellet 800 fps) | |
| Stock | Mil Spec Modular Precision Buttstock and Pistol Grip | | | | | | | |
| Overall Length | 1180mm (46.5") Stock Shortened 1260mm (49.6") Stock Extended | | | | | | | |
| Barrel Length | 760mm (30") | | | | | | | |
| Weight | 5kg (11.1lbs) | | | | | | | |
| Regulator | Externally Adjustable | | | | | | | |

(*) Velocity and Energy levels are stable shots at 140 bar regulator pressure.

1040fpsPOWER!
with Lead Pellets

QuietEnergySeries



FACTOR SNIPER S



**FULLY SHROUDED
BARREL**



FACTOR SNIPER S



FACTOR SNIPER S FDE



FACTOR SNIPER S BRONZE

| Model | Hatsan Factor Sniper S | | | | | |
|-------------------------------------|---|------------|-------------------------------------|-----------|------------------------------------|-----------|
| Caliber | 4.5mm / .177cal | | 5.5mm / .22cal | | 6.35mm / .25cal | |
| Max. Muzzle Velocity (*) | 306m/s (1040 fps) | 15gr slug | 288m/s (1000 fps) | 29gr slug | 318m/s (900 fps) | 45gr slug |
| Energy (*) | Joules up to 48,7 | | up to 87 | | up to 109 | |
| | ft.lbs up to 36 | up to 64,5 | up to 80 | | | |
| Magazine Capacity | 24 | | 21-45 | | 19-39 | |
| Air Tube Volume | 480cc (carbon fiber) | | | | | |
| Fill Pressure | 300 BAR | | | | | |
| Number of Shots at Optimal Velocity | 75 (9,5gr. pellet at 1150 fps) | | 75 (18,13gr. pellet at 1050 fps) | | 60 (33,95gr. at pellet 900 fps) | |
| Stock | Mil Spec Modular Precision Buttstock and Pistol Grip | | | | | |
| Overall Length | 1005mm (46.5") Stock Shortened 1085mm (49.6") Stock Extended | | | | | |
| Barrel Length | 585mm (23") | | | | | |
| Weight | 4.6kg (10,2 lbs) | | | | | |
| Regulator | Externally Adjustable | | | | | |

(*) Velocity and Energy levels are stable shots at 140 bar regulator pressure.







HATSAN
Serious Solid Impact



Serious. Solid. Impact

QuietEnergySeries

FACTOR

1170fpsPOWER!
with Lead Pellets



Tactical telescopic stock

Externally adjustable hammer preload (located on right side of the receiver)

Reversible cocking handle for ambidextrous operation



3 power adjustable Transfer Port

FULLY SHROUDED BARREL



Foster quick disconnect male fitting

500cc volume detachable aluminum air bottle

Elevation adjustable cheek rest

Vertical and horizontal trigger shoe adjustment

FACTOR FDE
Flat Dark Earth cerakote version

| Model | Hatsan Factor | | |
|-------------------------------------|---|------------------|-----------------|
| Caliber | 4.5mm / .177cal | 5.5mm / .22cal | 6.35mm / .25cal |
| Max. Muzzle Velocity (*) | 355m/s (1170fps) | 325m/s (1070fps) | 295m/s (970fps) |
| Energy (*) | Joules | 36 | 51 |
| | ft. lbs | 27 | 38 |
| Magazine Capacity | 24 | 21 | 19 |
| Air Tube Volume | 500cc (aluminum) | | |
| Fill Pressure | 250 BAR | | |
| Number of Shots Per Fill | 320 | 310 | 300 |
| Number of Shots at Optimal Velocity | 105 | 100 | 90 |
| Stock | Telescopic stock. Elevation adjustable cheek rest. Pistol grip. | | |
| Overall Length | 1025mm (40.3") Stock Shortened 1090mm (42.9") Stock Extended | | |
| Barrel Length | 585mm (23") | | |
| Weight | 3.6kg (7.9lbs) | | |

Manual loading, side lever action, pre-charged pneumatic (PCP) air rifle. Available in .177 (4.5mm), .22 (5.5mm) and .25 (6.35mm) caliber. 3 power adjustable Transfer Port. Externally adjustable hammer preload. QuietEnergy fully shrouded barrel and Integrated Sound Moderator – Approximately 50% Quieter. 1/2" UNF threaded muzzle for additional detachable sound moderators.

| Power Setting | Hatsan Factor Recommended Energy* 4.5mm / .177cal |
|---------------|--|
| 3 | 20 to 36 Joule |
| 2 | 11 to 30.5 Joule |
| 1 | 9.4 to 18.8 Joule |

| Power Setting | Hatsan Factor Recommended Energy* 5.5mm / .22cal |
|---------------|---|
| 3 | 35.8 to 51 Joule |
| 2 | 28 to 39 Joule |
| 1 | 19 to 22.9 Joule |

| Power Setting | Hatsan Factor Recommended Energy* 6.35mm / .22cal |
|---------------|--|
| 3 | 38 to 57 Joule |
| 2 | 30.5 to 41.5 Joule |
| 1 | 18 to 21.5 Joule |

* Energy Range "Min to Max" Hammer Preload.
** Energy Range with "Min to Max" Hammer Preload.

* Velocity results may vary as much as 20% due to pellet weight, pellet shape, temperature, elevation, as well as other factors.



- 500cc volume detachable aluminum air bottle.
- Spare aluminum air bottles are available.
- 580cc carbon fiber air bottle upgrade available.



(*) Scope sold separately

1010fpsPOWER!
with Lead Pellets

QuietEnergySeries



FACTOR RC

FULLY SHROUDED BARREL

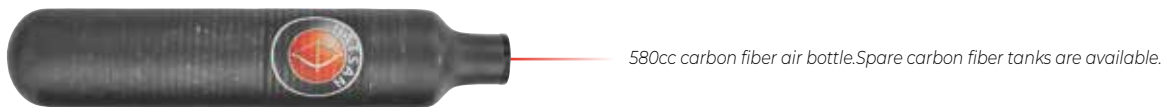

| Model | Hatsan Factor-RC | | | |
|-------------------------------------|---|-----------------|-----------------|------|
| | 4.5mm / .177cal | 5.5mm / .22cal | 6.35mm / .25cal | |
| Caliber | 4.5mm / .177cal | 5.5mm / .22cal | 6.35mm / .25cal | |
| Max. Muzzle Velocity (*) | 306m/s (1010fps) | 288m/s (950fps) | 265m/s (870fps) | |
| Energy (*) | Joules | 26.5 | 40 | 45.3 |
| | ft. lbs | 19.5 | 29.5 | 33.5 |
| Magazine Capacity | 24 | 21 | 19 | |
| Air Tube Volume | 580cc (carbon fiber) | | | |
| Fill Pressure | 250 BAR | | | |
| Number of Shots at Optimal Velocity | 140 | 130 | 120 | |
| Stock | Telescopic stock with adjustable comb and pistol grip | | | |
| Overall Length | 1025mm (40.3") Stock Shortened 1090mm (42.9") Stock Extended | | | |
| Barrel Length | 585mm (23") | | | |
| Weight | 3.6kg (7.9lbs) | | | |
| REGULATOR | EXTERNALLY ADJUSTABLE | | | |

Pressure adjustable Regulator and Carbon Fiber air bottle version. Manual loading, side lever action, pre-charged pneumatic (PCP) air rifle. Available in .177 (4.5mm), .22 (5.5mm) and .25 (6.35mm) caliber. 3 power adjustable Transfer Port. Externally adjustable hammer preload. Externally adjustable Regulator.

| Power Setting | Hatsan Factor-RC Recommended Energy** |
|---------------|---------------------------------------|
| | 4.5mm / .177cal |
| 3 | 19 to 26.5 Joule |
| 2 | 18 to 23 Joule |
| 1 | 12 to 14.5 Joule |

| Power Setting | Hatsan Factor-RC Recommended Energy** |
|---------------|---------------------------------------|
| | 5.5mm / .22cal |
| 3 | 25 to 40 Joule |
| 2 | 20 to 28 Joule |
| 1 | 12.4 to 16 Joule |

| Power Setting | Hatsan Factor-RC Recommended Energy** |
|---------------|---------------------------------------|
| | 6.35mm / .25cal |
| 3 | 27 to 45.3 Joule |
| 2 | 23 to 31 Joule |
| 1 | 12.6 to 15.6 Joule |

* Velocity and Energy levels are stable shots at 140bar regulator pressure.

** Energy Range "Min to Max" Hammer Preload

** Energy Range with "Min to Max" Hammer Preload and Regulator at 140 BAR.



Serious. Solid. Impact

QuietEnergy Series

1100fps POWER!
with Lead Pellets

FACTOR BP



Pressure adjustable Regulator and 580cc volume detachable carbon fiber air bottle. Spare carbon air bottles are available. 3 power adjustable Transfer Port. Externally adjustable hammer preload. 1/2" UNF threaded muzzle for additional detachable sound moderators. Built-in pressure gauge to monitor the cylinder pressure. Additional air gauge to monitor the regulator pressure. Finger distance to the trigger shoe can be adjusted by 15 mm. Quattro Trigger: 2-stage full adjustable match trigger for trigger travel and trigger load. Vertical and horizontal trigger shoe adjustment. Patented anti-knock system to prevent discharge of the rifle when rifle is knocked or bounced.

| Model | Hatsan Factor BP | | | |
|-------------------------------------|-----------------------|------------------|-----------------|------|
| Caliber | 4.5mm / .177cal | 5.5mm / .22cal | 6.35mm / .25cal | |
| Max. Muzzle Velocity (*) | 333m/s (1100fps) | 324m/s (1070fps) | 294m/s (970fps) | |
| Energy (*) | Joules | 31,5 | 50,5 | 56,4 |
| | ft. lbs | 23,2 | 37,25 | 41,6 |
| Magazine Capacity | 24 | 21 | 19 | |
| Air Tube Volume | 580cc (carbon fiber) | | | |
| Fill Pressure | 250 BAR | | | |
| Number of Shots at Optimal Velocity | 70 | 60 | 50 | |
| Stock | | | | |
| Overall Length | 870mm(34.25") | | | |
| Barrel Length | 585mm (23") | | | |
| Weight | 3.8kg (8.38 lbs) | | | |
| Regulator | Externally Adjustable | | | |

* Velocity and Energy levels are stable shots at 150bar regulator pressure.

| Power Setting | Hatsan Factor-BP Recommended Energy** |
|---------------|---------------------------------------|
| | 4,5mm / .177 cal |
| 3 | 31,5 to 25 Joule |
| 2 | 25 to 21 Joule |
| 1 | 14,6 to 16,6 Joule |
| Power Setting | Hatsan Factor-BP Recommended Energy** |
| | 5,5mm / .22cal |
| 3 | 41,5 to 50,5 Joule |
| 2 | 31 to 35 Joule |
| 1 | 17,5 to 20,4 Joule |
| Power Setting | Hatsan Factor-BP Recommended Energy** |
| | 6.35mm / .25cal |
| 3 | 41,3 to 56,4 Joule |
| 2 | 33 to 38 Joule |
| 1 | 21,5 to 24 Joule |

* Energy Range "Min to Max" Hammer Preload.
** Energy Range with "Min to Max" Hammer Preload and Regulator at 150 BAR.

Pistol Grip can be set to different locations for small; medium or big fingers. Finger distance to the trigger shoe can be adjusted by 15 mm.

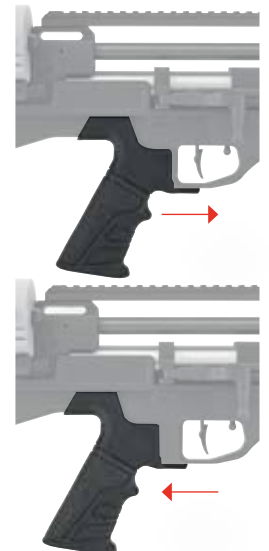

970fps POWER!
with Lead Pellets

QuietEnergy Series



Serious. Solid. Impact

FACTOR FT

FT Butt Plate; The plate can be adjusted up/down and can be angled into you to give a consistent shoulder position.

Elevation adjustable cheek rest.

Combo scope rail; (11mm&22mm).

Externally adjustable regulator.

QuietEnergy fully shrouded, precision rifled and choked barrel.

FULLY SHROUDED BARREL



Externally adjustable hammer preload.

Soft rubber pistol grip. Pistol Grip can be set to different locations for small, medium or big fingers. Finger distance to the trigger shoe can be adjusted by 15mm.

Quattro Trigger: 2-stage full adjustable match trigger for trigger travel and trigger load.

Foster style quick disconnect fill inlet.

Removable Picatinny accessory rail for bipod.

400cc air cylinder, 200 BAR max fill pressure.

| Model | Hatsan Factor FT | | | |
|-------------------------------------|-------------------------------|-----------------|-----------------|------|
| Caliber | 4.5mm / .177cal | 5.5mm / .22cal | 6.35mm / .25cal | |
| Max. Muzzle Velocity (*) | 294m/s (970fps) | 275m/s (910fps) | 252m/s (830fps) | |
| Energy (*) | Joules | 24,5 | 36,5 | 41 |
| | ft.lbs | 18 | 27 | 30,5 |
| Magazine Capacity | 24 | 21 | 19 | |
| Air Tube Volume | 400cc | | | |
| Fill Pressure | 200 BAR | | | |
| Number of Shots at Optimal Velocity | 60 | 60 | 60 | |
| Stock | FT Butt Plate and Pistol Grip | | | |
| Overall Length | 920mm (36.2") | | | |
| Barrel Length | 450mm (17.7") | | | |
| Weight | 3.75kg (8.33 lbs) | | | |
| Regulator | EXTERNALLY ADJUSTABLE | | | |

(*) Velocity and Energy levels are stable shots at 125 bar regulator pressure.

| Power Setting | Hatsan Factor FT Recommended Energy** 4.5mm / .177cal |
|---------------|---|
| 3 | 14,6-28,7 joule |
| 2 | 11,7-20,1 joule |
| 1 | 7,9-11,3 joule |

| Power Setting | Hatsan Factor FT Recommended Energy** 5.5mm / .22cal |
|---------------|--|
| 3 | 20,4-36,5 joule |
| 2 | 16,4-26,8 joule |
| 1 | 10,2-15,4 joule |

| Power Setting | Hatsan Factor FT Recommended Energy** 6.35mm / .25cal |
|---------------|---|
| 3 | 23,8-41,3 joule |
| 2 | 13,8-27,7 joule |
| 1 | 8,2-13,2 joule |

* Energy Range "Min to Max" Hammer Preload

** Energy Range with "Min to Max" Hammer Preload and Regulator at 140 BAR





Serious. Solid. Impact

QuietEnergy Series

1300fps POWER!
with Lead Pellets

HERCULES

Available in **45** cal.

FULLY SHROUDED
BARREL



QE QuietEnergy Version
QE fully shrouded barrel and
Integrated Sound Moderator -
Approximately 50% Quieter.

Elevation & fit angle adjustable rubber butt
pad and elastic cheek piece.

- Side lever action.
- Picatinny rail milled receiver for both 11mm and 22mm scope mounts.
- 2-stage adjustable trigger for trigger travel and trigger load
- Detachable 17-shot magazine in .177 (4.5mm), 14-shot magazine in .22 (5.5mm), 10-shot magazine in .30 (7.62mm) and 9-shot magazine in .35 (9mm) caliber.



(* Scope sold separately)



Manual loading, side-lever action, pre-charged pneumatic (PCP) air rifle. Precision rifled choked barrel for accuracy. 2 air tube bottles of each 500cc. Overall blued finish, black anodized receiver. "Anti-double pellet feed" mechanism preventing more than one pellet loading into barrel. 2-stage adjustable trigger for trigger travel and trigger load. Black metal trigger.

| Model | Hercules | | | | | | |
|-------------------------------------|--|------------------|------------------|-----------------|-----------------|------------------|-----|
| Caliber | 4.5mm / .177cal | 5.5mm / .22cal | 6.35mm / .25cal | 7.62mm / .30cal | 9mm / .35cal | 11.43mm / .45cal | |
| Max. Muzzle Velocity (*) | 396m/s (1300fps) | 375m/s (1230fps) | 365m/s (1200fps) | 300m/s (990fps) | 271m/s (890fps) | 224m/s (741fps) | |
| Energy (*) | Joules | 44 | 67 | 87 | 132 | 193 | 396 |
| | ft. lbs | 32,5 | 49 | 64 | 97 | 142,5 | 292 |
| Magazine Capacity | 17 | 14 | 13 | 10 | 9 | 7 | |
| Air Tube Volume | 2 x 500cc | | | | | | |
| Fill Pressure | 250 BAR | | | | | | |
| Number of Shots Per Fill | 140 | 120 | 120 | 85 | 72 | 37 | |
| Number of Shots at Optimal Velocity | 70 | 65 | 62 | 51 | 48 | 15 | |
| Stock | Advanced polymer, tactical stock with integrated pistol grip | | | | | | |
| Overall Length | 1230mm (48.4") | | | | | | |
| Barrel Length | 585mm (23") | | | | | | |
| Weight | 5.9kg (13lbs) | | | | | | |

*Velocity results may vary as much as 20% due to pellet weight, pellet shape, temperature, elevation, as well as other factors.

1300fps POWER!
with Lead Pellets

QuietEnergy Series



HERCULES BULLY

Available in **45** cal.

**FULLY SHROUDED
BARREL**



QuietEnergy Version
QE fully shrouded barrel and
Integrated Sound Moderator -
Approximately 50% Quieter.

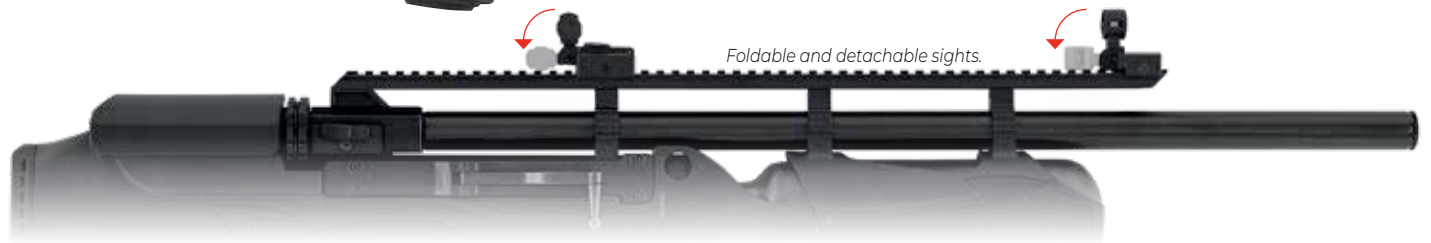

Foldable and detachable sights.



(* Scope sold separately)

Genuine bullpup design, manual loading, side-lever action, pre-charged pneumatic (PCP) air rifle. 500cc volume air bottle mounted in the forearm. "Anti-double pellet feed" mechanism preventing more than one pellet loading into barrel. 2-stage adjustable trigger for trigger travel and trigger load. Black metal trigger.

| Model | | Hercules Bully | | | | | |
|--|--------------------|--|------------------|------------------|-----------------|-----------------|------------------|
| Caliber | | 4.5mm / .177cal | 5.5mm / .22cal | 6.35mm / .25cal | 7.62mm / .30cal | 9mm / .35cal | 11.43mm / .45cal |
| Max. Muzzle Velocity (*) | | 396m/s (1300fps) | 375m/s (1230fps) | 365m/s (1200fps) | 300m/s (990fps) | 271m/s (890fps) | 224m/s (741fps) |
| Energy (*) | Joules | 44 | 67 | 87 | 132 | 193 | 396 |
| | ft. lbs | 32,5 | 49 | 64 | 97 | 142,5 | 292 |
| Magazine Capacity | | 17 | 14 | 13 | 10 | 9 | 7 |
| Air Tube Volume | | 500cc | | | | | |
| Fill Pressure | | 250 BAR | | | | | |
| Number of Shots Per Fill | | 95 | 85 | 80 | 50 | 45 | 19 |
| Number of Shots at Optimal Velocity | | 45 | 40 | 36 | 15 | 13 | 8 |
| Stock | | Advanced polymer, tactical bullpup stock with integrated pistol grip | | | | | |
| Overall Length | | 920mm (36.2") | | | | | |
| Barrel Length | | 585mm (23") | | | | | |
| Weight | | 4.65kg (10.3lbs) | | | | | |
| Fiber Optic Sights Diameters | Rear Sight | 0.9mm (.035") green | | | | | |
| | Front Sight | 1.5mm (.060") red | | | | | |

* Velocity results may vary as much as 20% due to pellet weight, pellet shape, temperature, elevation, as well as other factors.



Serious. Solid. Impact

1100fps POWER!
with Lead Pellets

PILEDRIVER

Big Bore Pcp



PILEDRIVER



.25 ; .30; 35; 45; .50; .62 cal



Large loading port loads ammo up to 34mm in length.

| Model | PILEDRIVER | | | | | | |
|--------------------------|-------------------------|------------------|------------------|------------------|-----------------|-----------------|-----|
| Caliber | 6,35mm / .25cal | 7.62mm / ,30 cal | 9mm / ,35 cal | 11,45mm / .45cal | 12,7mm / .50cal | 15.8mm / .62cal | |
| Max. Muzzle Velocity (*) | 333m/s (1100fps) | 318m/s (1050fps) | 303m/s (1000fps) | 268m/s (885fps) | 218m/s (720fps) | 213m/s (700fps) | |
| Energy (*) | Joules | 168 | 266 | 436 | 955 | 1100 | 955 |
| | ft.lbs | 124 | 196 | 322 | 700 | 800 | 700 |
| Air Tube Volume | 480cc (carbon fiber) | | | | | | |
| Fill Pressure | 300 BAR | | | | | | |
| Number of Shotsper fill | 30 | 25 | 15 | 5 | 5 | 4 | |
| Stock | Bullpup Synthetic Stock | | | | | | |
| Overall Length | 1125mm (44,3") | 1190mm (46,5") | | | | 1130.3mm (44.5) | |
| Barrel Length | 750mm (29,5") | 890mm (35") | | | | 838mm (33") | |
| Weight | 4.66kg (10.35lbs) | | | | | | |

(*) Velocity results may vary as much as 20% due to pellet weight, pellet shape, temperature elevation as well as other factors.

141joules**POWER!**

QuietEnergy**Series**



Serious. Solid. Impact

BT65 CARNIVORE

7.62mm & 9mm

**FULLY SHROUDED
BARREL**



BT65SL CARNIVORE



QuietEnergy Version
QE fully shrouded barrel and
Integrated Sound Moderator -
Approximately 50% Quieter.

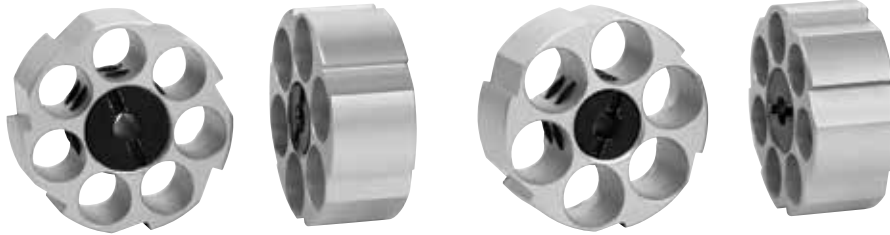

7.62mm (.30cal) - 7 shot magazine

9mm (.35cal) - 6 shot magazine



BT65SL-W CARNIVORE

Side bolt walnut stock version

Pre Charged Pneumatic (PCP), side lever action, multi shot air rifle. Precision rifled barrel for accuracy. Available in .30 (7.62mm) and .35 (9mm) caliber. Detachable aluminum air cylinder tube (255cc). Spare cylinders are available. "Anti-double pellet feed" mechanism preventing more than one pellet loading into barrel. Patented Anti-Knock System to prevent gas wastage when rifle is knocked or bounced. Quattro Trigger: 2-stage full adjustable match trigger for trigger travel and trigger load. Gold plated metal trigger & metal trigger guard.

| Model | | BT65SL Carnivore | |
|-------------------------------------|---------|--|-----------------|
| Caliber | | 7.62mm / .30cal | 9mm / .35cal |
| Max. Muzzle Velocity (*) | | 278m/s (920fps) | 230m/s (760fps) |
| Energy | Joules | 114 | 141 |
| | ft. lbs | 84 | 104 |
| Magazine Capacity | | 7 | 6 |
| Air Tube Volume | | 255cc | |
| Fill Pressure | | 200 BAR | |
| Shots Per Fill | | 55 | 50 |
| Number of Shots at Optimal Velocity | | 19 | 17 |
| Stock | | Advanced Polymer or Walnut, montecarlo cheekpiece, adjustable butt pad & adjustable comb | |
| Overall Length | | 1240mm (48.8") | |
| Barrel Length | | 585mm (23") | |
| Weight | | 4.20kg (9.3lbs) | |

* Velocity results may vary as much as 20% due to pellet weight, pellet shape, temperature, elevation, as well as other factors.

JET III

3 Integrated, adjustable flip-up sights.

QuietEnergy fully shrouded barrel and integrated sound moderator



Regulator.

Removable dual 40cc (80cc total) air cylinders fill to 250 BAR.

22mm picatinny rail.



JET III



**JET III
RED**



**JET III
BLUE**



**JET III
GREEN**

725fpsPOWER!
with Lead Pellets



Serious. Solid. Impact

Elevation adjustable cheek rest.



*Lightweight, telescoping,
detachable buttstock with
rubber buttpad.*



(*) Scope sold separately.



| Model | JET III | | | |
|-------------------------------------|----------------------------------|------------------|-----------------|------|
| Caliber | 4.5mm / .177cal | 5.5mm / .22cal | 6.35mm / .25cal | |
| Max. Muzzle Velocity (*) | 220m/s (725fps) | 200 m/s (660fps) | 177m/s (585fps) | |
| Energy (*) | Joules | 13,7 | 19 | 20,5 |
| | ft. lbs | 10 | 14 | 15 |
| Magazine Capacity | 8 | 7 | 6 | |
| Air Tube Volume | 40+40 cc | | | |
| Fill Pressure | 250 BAR | | | |
| Number of Shots at Optimal Velocity | 31 | 30 | 28 | |
| Stock | Advanced polymer | | | |
| Overall Length(rifle) | 835mm -790mm (32,9"-31,1") rifle | | | |
| Barrel Length | 300mm (11,8") | | | |
| Weight | 1,9 kg (4,2 lbs) | | | |

(*) Velocity and Energy levels are stable shots at 125 bar regulator pressure



Serious. Solid. Impact

780fps POWER!
with Lead Pellets

JET I



JET I



**JET I
BLUE**



**JET I
RED**



**JET I
GREEN**

| Model | | JET I | | |
|-------------------------------------|---------|-----------------------------|-----------------|-----------------|
| Caliber | | 4.5mm / .177cal | 5.5mm / .22cal | 6.35mm / .25cal |
| Max. Muzzle Velocity (*) | | 235m/s (780fps) | 210m/s (700fps) | 197m/s (650fps) |
| Energy (*) | Joules | 16 | 21,5 | 25,3 |
| | ft. lbs | 11,6 | 16 | 18,7 |
| Magazine Capacity | | 8 | 7 | 6 |
| Air Tube Volume | | 40 cc | | |
| Fill Pressure | | 250 BAR | | |
| Number of Shots per fill | | 60 | 55 | 52 |
| Number of Shots at Optimal Velocity | | 18 | 16 | 15 |
| Stock | | Advanced Polymer | | |
| Overall Length (pistol) | | 380mm (15") pistol | | |
| Overall Length (rifle) | | 625-580mm (24.6-22.8) rifle | | |
| Barrel Length | | 200mm (7,9") | | |
| Weight | | 0,9 kg (2 lbs) | | |
| Weight (rifle) | | 1,34 kg (2,9 lbs) | | |

(*) Velocity results may vary as much as 20% due to pellet weight, pellet shape, temperature elevation as well as other factors.



650fpsPOWER!
with Lead Pellets



Serious. Solid. Impact

JET I RG



| Model | | JET I RG | | |
|-------------------------------------|--------|-----------------------------|------------------|-----------------|
| Caliber | | 4.5mm / .177cal | 5.5mm / .22cal | 6.35mm / .25cal |
| Max. Muzzle Velocity (*) | | 197m/s (650fps) | 182 m/s (600fps) | 166m/s (550fps) |
| Energy (*) | Joules | 11 | 15,8 | 18 |
| | ft.lbs | 8,1 | 11,7 | 13,3 |
| Magazine Capacity | | 8 | 7 | 6 |
| Air Tube Volume | | 40 cc | | |
| Fill Pressure | | 250 BAR | | |
| Number of Shots at Optimal Velocity | | 21 | 20 | 18 |
| Stock | | Advanced polymer | | |
| Overall Length(pistol) | | 455mm (17,9") pistol | | |
| Overall Length(rifle) | | 700-655mm (27,5-25,8) rifle | | |
| Barrel Length | | 200mm (7,9") | | |
| Weight | | 1,1 kg (2,4 lbs) | | |
| Weight(rifle) | | 1,54 kg (3,4 lbs) | | |

(*) Velocity and Energy levels are stable shots at 125 bar regulator pressure.



JET I RG



**JET I RG
BLUE**



**JET I RG
RED**



**JET I RG
GREEN**



Serious. Solid. Impact

780fps POWER!
with Lead Pellets

JET II



JET II



JET II BLUE



JET II RED



JET II GREEN



| Model | JET II | | | |
|-------------------------------------|-----------------------------|-----------------|-----------------|------|
| Caliber | 4.5mm / .177cal | 5.5mm / .22cal | 6.35mm / .25cal | |
| Max. Muzzle Velocity (*) | 235m/s (780fps) | 210m/s (700fps) | 197m/s (650fps) | |
| Energy (*) | Joules | 16 | 21,5 | 25,3 |
| | ft.lbs | 11,6 | 16 | 18,7 |
| Magazine Capacity | 8 | 7 | 6 | |
| Air Tube Volume | 40+40 cc | | | |
| Fill Pressure | 250 BAR | | | |
| Number of Shots per fill | 125 | 120 | 115 | |
| Number of Shots at Optimal Velocity | 38 | 35 | 32 | |
| Stock | Advanced polymer | | | |
| Overall Length(pistol) | 380mm (15") pistol | | | |
| Overall Length(rifle) | 625-580mm (24.6-22.8) rifle | | | |
| Barrel Length | 200mm (7,9") | | | |
| Weight | 1,1 kg (2,4 lbs) | | | |
| Weight(rifle) | 1,54 kg (3,4 lbs) | | | |

(*) Velocity results may vary as much as 20% due to pellet weight, pellet shape, temperature elevation as well as other factors.

650fpsPOWER!
with Lead Pellets



Serious. Solid. Impact

JET II RG



JET II RG



**JET II RG
RED**



**JET II RG
BLUE**



**JET II RG
GREEN**



| Model | JET II RG | | |
|-------------------------------------|-----------------------------|------------------|-----------------|
| Caliber | 4.5mm / .177cal | 5.5mm / .22cal | 6.35mm / .25cal |
| Max. Muzzle Velocity (*) | 197m/s (650fps) | 182 m/s (600fps) | 166m/s (550fps) |
| Energy (*) | Joules | 11 | 15,8 |
| | ft. lbs | 8,1 | 11,7 |
| Magazine Capacity | 8 | 7 | 6 |
| Air Tube Volume | 40+40 cc | | |
| Fill Pressure | 250 BAR | | |
| Number of Shots at Optimal Velocity | 42 | 40 | 37 |
| Stock | Advanced polymer | | |
| Overall Length(pistol) | 455mm (17,9") pistol | | |
| Overall Length(rifle) | 700-655mm (27,5-25,8) rifle | | |
| Barrel Length | 200mm (7,9") | | |
| Weight | 1,3 kg (2,9 lbs) | | |
| Weight(rifle) | 1,74 kg (3,9 lbs) | | |

(*) Velocity and Energy levels are stable shots at 125 bar regulator pressure.



Serious. Solid. Impact

QuietEnergy Series

1010fps POWER!
with Lead Pellets

NOVA STAR PREMIUM



FULLY SHROUDED
BARREL



QE
QuietEnergy
QuietEnergy Version
QE fully shrouded barrel and
Integrated Sound Moderator -
Approximately 50% Quieter.



NOVA STAR
PREMIUM RED



NOVA STAR
PREMIUM BLUE

| Model | | Novastar Premium | | |
|-------------------------------------|---------|----------------------------------|-----------------|-----------------|
| Caliber | | 4.5mm / .177cal | 5.5mm / .22cal | 6.35mm / .25cal |
| Max. Muzzle Velocity (*) | | 306m/s (1010fps) | 288m/s (950fps) | 264m/s (870fps) |
| Energy (*) | Joules | 26.5 | 40 | 45.3 |
| | ft. lbs | 19.5 | 29.5 | 33.5 |
| Magazine Capacity | | 14 | 12 | 10 |
| Air Tube Volume | | 580cc (carbon fiber) | | |
| Fill Pressure | | 250 BAR | | |
| Number of Shots at Optimal Velocity | | 140 | 130 | 120 |
| Stock | | Red or Blue Laminated Wood Stock | | |
| Overall Length | | 1120 | | |
| Barrel Length | | 585mm (23") | | |
| Weight | | 4.2kg (9.26lbs) | | |
| Regulator | | Externally Adjustable | | |

* Velocity and Energy levels are stable shots at 140bar regulator pressure.

Pressure adjustable Regulator and Carbon Fiber air bottle version. 580cc volume detachable carbon fiber air bottle. Spare carbon air bottles are available. Manual loading, side lever action, pre-charged pneumatic (PCP) air rifle. Laminated Wood stock-Elevation adjustable comb and picantiny rail beneath the forearm. Patented anti-knock system to prevent gas wastage when rifle is knocked or bounced. Quattro Trigger: 2-stage full adjustable match trigger for trigger travel and trigger load. Gold plated metal trigger & metal trigger guard.

1220fpsPOWER!
with Lead Pellets

QuietEnergySeries



NOVA STAR SYN



(* Scope sold separately.)

**FULLY SHROUDED
BARREL**



NOVA STAR SYN



**NOVA STAR SYN
QE**



**NOVA STAR SYN
MOONSHINE**



**NOVA STAR SYN
QE MOONSHINE**



| Model | NOVASTAR SYN | | | NOVASTAR SYN QE | | |
|-------------------------------------|----------------------|------------------|------------------|----------------------|------------------|------------------|
| Caliber | 4.5mm / .177cal | 5.5mm / .22cal | 6.35mm / .25cal | 4.5mm / .177cal | 5.5mm / .22cal | 6.35mm / .25cal |
| Max. Muzzle Velocity (*) | 370m/s (1220fps) | 335m/s (1100fps) | 310m/s (1020fps) | 370m/s (1220fps) | 335m/s (1100fps) | 310m/s (1020fps) |
| Energy (*) | Joules | 39 | 53.5 | 63 | 39 | 53.5 |
| | ft.lbs | 29 | 39.5 | 46 | 29 | 39.5 |
| Magazine Capacity | 14 | 12 | 10 | 14 | 12 | 10 |
| Air Tube Volume | 480cc (carbon fiber) | | | 480cc (carbon fiber) | | |
| Fill Pressure | 250 BAR | | | 250 BAR | | |
| Number of Shotsper fill | 320 | 300 | 280 | 320 | 300 | 280 |
| Number of Shots at Optimal Velocity | 110 | 100 | 90 | 110 | 100 | 90 |
| Stock | | | | | | |
| Overall Length | 1095mm | | | 1240mm | | |
| Barrel Length | 585mm (23") | | | 585mm (23") | | |
| Weight | 3,75kg (8.33lbs) | | | 3,75kg (8.33lbs) | | |

(*) Velocity results may vary as much as 20% due to pellet weight, pellet shape, temperature elevation as well as other factors.



Serious. Solid. Impact

QuietEnergy Series

1220fps POWER!
with Lead Pellets

NOVA STAR

FULLY SHROUDED
BARREL



NOVASTAR QE

QuietEnergy Version
QE fully shrouded barrel and
Integrated Sound Moderator -
Approximately 50% Quieter.



Includes 2 magazines
and quick fill nozzle.



(* Scope sold separately)

| Model | NovaStar | | | NovaStar QE | | |
|-------------------------------------|---|------------------|------------------|---|------------------|------------------|
| Caliber | 4.5mm / .177cal | 5.5mm / .22cal | 6.35mm / .25cal | 4.5mm / .177cal | 5.5mm / .22cal | 6.35mm / .25cal |
| Max. Muzzle Velocity (*) | 370m/s (1220fps) | 335m/s (1100fps) | 310m/s (1020fps) | 370m/s (1220fps) | 335m/s (1100fps) | 310m/s (1020fps) |
| Energy (*) | Joules | 39 | 53,5 | 63 | 39 | 53,5 |
| | ft. lbs | 29 | 39,5 | 46 | 29 | 39,5 |
| Magazine Capacity | 14 | 12 | 10 | 14 | 12 | 10 |
| Air Tube Volume | 480cc | | | 480cc | | |
| Fill Pressure | 250 BAR | | | 250 BAR | | |
| Number of Shots per fill | 320 | 300 | 280 | 320 | 300 | 280 |
| Number of Shots at Optimal Velocity | 110 | 100 | 90 | 110 | 100 | 90 |
| Stock | Genuine Turkish High Grade walnut, Thumbhole, Adjustable Cheek Rest. Adjustable Butt Pad. | | | Genuine Turkish High Grade walnut, Thumbhole, Adjustable Cheek Rest. Adjustable Butt Pad. | | |
| Overall Length | 1095mm (43.1") | | | 1240mm (48.8") | | |
| Barrel Length | 585mm (23") | | | 585mm (23") | | |
| Weight | 3.8kg (8.4lbs) | | | 3.8kg (8.4lbs) | | |

* Velocity results may vary as much as 20% due to pellet weight, pellet shape, temperature, elevation, as well as other factors.

1220fps POWER!
with Lead Pellets

QuietEnergy Series



Serious. Solid. Impact

NOVA

**FULLY SHROUDED
BARREL**



QuietEnergy Version
QE fully shrouded barrel and
Integrated Sound Moderator -
Approximately 50% Quieter.



NOVA COMPACT

Compact version without sound
moderator. Shrouded barrel and
1/2" UNF threaded muzzle for
detachable sound moderator.



NOVATACT



QuietEnergy Version
QE fully shrouded barrel and
Integrated Sound Moderator -
Approximately 50% Quieter.



NOVATACT COMPACT

Compact version without QE sound
moderator. Shrouded barrel and
1/2" UNF threaded muzzle for
detachable sound moderator.

| Model | Nova | | |
|-------------------------------------|---|------------------|------------------|
| Caliber | 4.5mm / .177cal | 5.5mm / .22cal | 6.35mm / .25cal |
| Max. Muzzle Velocity (*) | 370m/s (1220fps) | 335m/s (1100fps) | 310m/s (1020fps) |
| Energy (*) | Joules | 39 | 53,5 |
| | ft.lbs | 29 | 39,5 |
| Magazine Capacity | 10 | 10 | 9 |
| Air Tube Volume | 500cc | | |
| Fill Pressure | 250 BAR | | |
| Number of Shots Per Fill | 325 | 300 | 280 |
| Number of Shots at Optimal Velocity | 150 | 130 | 115 |
| Stock | Genuine Turkish walnut, montecarlo cheekpiece, adjustable butt pad. | | |
| Overall Length | 1245 mm (49") | | |
| Barrel Length | 585mm (23") | | |
| Weight | 4.4 kg (9.7lbs) | | |

* Velocity results may vary as much as 20% due to pellet weight, pellet shape, temperature, elevation, as well as other factors.

| Model | NovaTact | | |
|-------------------------------------|--|--------------------|--------------------|
| Caliber | 4.5mm / .177cal | 5.5mm / .22cal | 6.35mm / .25cal |
| Max. Muzzle Velocity (*) | 370m/s (1220fps) | 335 m/s (1100 fps) | 310 m/s (1020 fps) |
| Energy (*) | Joules | 39 | 53,5 |
| | ft.lbs | 29 | 39,5 |
| Magazine Capacity | 10 | 10 | 9 |
| Air Tube Volume | 500cc | | |
| Fill Pressure | 250 BAR | | |
| Number of Shots Per Fill | 325 | 300 | 280 |
| Number of Shots at Optimal Velocity | 150 | 130 | 115 |
| Stock | Tactical Telescopic Stock Adjustable Comb Advanced Polymer Grip | | |
| Overall Length | Butt Shortened | 1173mm (46.1") | |
| | Butt Extended | 1273mm (50.1") | |
| Barrel Length | 585mm (23") | | |
| Weight | 4.8kg (10.6lbs) | | |



QuietEnergy Series

1070fps POWER!
with Lead Pellets

HYDRA

Multi-Caliber

**FULLY SHROUDED
BARREL**



Hydra's patented Versi-Cal Technology (VCT) system couples a caliber-specific receiver and barrel into a single interchangeable module. It allows for quick and simple multi caliber interchangeability. Unscrew the convenient upper receiver bolt to switch between .177, .22, or .25 caliber variants. This allows a scope to remain mounted and zeroed with each caliber barrel/receiver module, eliminating the need to re-zero each time the barrel is interchanged.
(*Additional caliber-specific barrel/receiver modules are available separately.)



Multi caliber interchangeable, multi-shot, bolt action pre-charged pneumatic (PCP) air rifle.



- Genuine Turkish walnut ambidextrous & ergonomic stock with Monte Carlo cheek piece.
- Checkering on grip & forend for better control & feel.
- Elevation and fit angle adjustable rubber butt pad.

| Model | Hydra | | | Hydra QE | | |
|-------------------------------------|--|-----------------|-----------------|--|-----------------|-----------------|
| Caliber | 4.5mm / .177cal | 5.5mm / .22cal | 6.35mm / .25cal | 4.5mm / .177cal | 5.5mm / .22cal | 6.35mm / .25cal |
| Max. Muzzle Velocity (*) | 325m/s (1070fps) | 295m/s (970fps) | 265m/s (870fps) | 325m/s (1070fps) | 295m/s (970fps) | 265m/s (870fps) |
| Energy (*) | Joules | 30 | 42 | 46 | 30 | 42 |
| | ft.lbs | 22 | 31 | 34 | 22 | 31 |
| Magazine Capacity | 14 | 12 | 10 | 14 | 12 | 10 |
| Air Tube Volume | 165cc | | | 165cc | | |
| Fill Pressure | 200 BAR | | | 200 BAR | | |
| Number of Shots per fill | 100 | 95 | 90 | 100 | 95 | 90 |
| Number of Shots at Optimal Velocity | 48 | 40 | 38 | 48 | 40 | 38 |
| Stock | Turkish Walnut. Elevation and fit angle adjustable butt pad. | | | Turkish Walnut. Elevation and fit angle adjustable butt pad. | | |
| Overall Length | 945 mm (37") | | | 1085mm (42.7") | | |
| Barrel Length | 450mm (17.7") | | | 450mm (17.7") | | |
| Weight | 2.99 kg (6.6lbs) | | | 3.09 kg (6.8lbs) | | |

*Velocity results may vary as much as 20% due to pellet weight, pellet shape, temperature, elevation, as well as other factors.

1070fps POWER!
with Lead Pellets

QuietEnergy Series



HYDRA Multi-Caliber SYN



**FULLY SHROUDED
BARREL**



HYDRA SYN QE



QuietEnergy Version
QE fully shrouded barrel and
Integrated Sound Moderator -
Approximately 50% Quieter.



**HYDRA SYN
MOONSHINE**



**HYDRA SYN
QE MOONSHINE**



Versi-Cal Technology



QuietEnergy Version
QE fully shrouded barrel and
Integrated Sound Moderator -
Approximately 50% Quieter.

Hydra's patented Versi Cal Technology (VCT) system couples a caliber-specific receiver and barrel into a single interchangeable module. It allows for quick and simple multi caliber interchangeability. Unscrew the convenient upper receiver bolt to switch between .177, .22, or .25 caliber variants. This allows a scope to remain mounted and zeroed with each caliber barrel/receiver module, eliminating the need to re-zero each time the barrel is interchanged. (*Additional caliber-specific barrel/receiver modules are available separately)

| Model | HYDRA SYN | | | HYDRA SYN QE | | |
|-------------------------------------|--------------------|-----------------|-----------------|--------------------|-----------------|-----------------|
| Caliber | 4.5mm / .177cal | 5.5mm / .22cal | 6.35mm / .25cal | 4.5mm / .177cal | 5.5mm / .22cal | 6.35mm / .25cal |
| Max. Muzzle Velocity (*) | 325m/s (1070fps) | 295m/s (970fps) | 265m/s (870fps) | 325m/s (1070fps) | 295m/s (970fps) | 265m/s (870fps) |
| Energy (*) | Joules | 30 | 42 | 46 | 30 | 42 |
| | ft. lbs | 22 | 31 | 34 | 22 | 31 |
| Magazine Capacity | 14 | 12 | 10 | 14 | 12 | 10 |
| Air Tube Volume | 215 cc | | | 215 cc | | |
| Fill Pressure | 200 BAR | | | 200 BAR | | |
| Number of Shots per fill | 145 | 140 | 135 | 145 | 140 | 135 |
| Number of Shots at Optimal Velocity | 55 | 50 | 47 | 55 | 50 | 47 |
| Stock | Advanced polymer | | | Advanced polymer | | |
| Overall Length | 940mm (37") | | | 1080mm (42.5") | | |
| Barrel Length | 450mm (17.7") | | | 450mm (17.7") | | |
| Weight | 3,17 kg (7.04 lbs) | | | 3,27 kg (7.26 lbs) | | |

(*) Velocity results may vary as much as 20% due to pellet weight, pellet shape, temperature elevation as well as other factors.



Serious. Solid. Impact

QuietEnergy Series

1070fps POWER!
with Lead Pellets

FLASH



QUATTRO TRIGGER

FULLY SHROUDED BARREL



FLASH QE

QE QuietEnergy Version
QE fully shrouded barrel and Integrated Sound Moderator - Approximately 50% Quieter.



(*) Scope sold separately

Single shot adapter is included.

| Model | Flash | | | Flash QE | | |
|-------------------------------------|------------------|-----------------|-----------------|------------------|-----------------|-----------------|
| Caliber | 4.5mm / .177cal | 5.5mm / .22cal | 6.35mm / .25cal | 4.5mm / .177cal | 5.5mm / .22cal | 6.35mm / .25cal |
| Max. Muzzle Velocity (*) | 325m/s (1070fps) | 295m/s (970fps) | 265m/s (870fps) | 325m/s (1070fps) | 295m/s (970fps) | 265m/s (870fps) |
| Energy (*) | Joules | 30 | 42 | 46 | 30 | 42 |
| | ft.lbs | 22 | 31 | 34 | 22 | 31 |
| Magazine Capacity | 14 | 12 | 10 | 14 | 12 | 10 |
| Air Tube Volume | 165cc | | | 165cc | | |
| Fill Pressure | 200 BAR | | | 200 BAR | | |
| Number of Shots per fill | 100 | 95 | 90 | 100 | 95 | 90 |
| Number of Shots at Optimal Velocity | 48 | 40 | 38 | 48 | 40 | 38 |
| Stock | Advanced polymer | | | Advanced Polymer | | |
| Overall Length | 915mm (36") | | | 1075mm (42.3") | | |
| Barrel Length | 450mm (17.7") | | | 450mm (17.7") | | |
| Weigh | 2.5kg (5.5lbs) | | | 2.68kg (5.9lbs) | | |

* Velocity results may vary as much as 20% due to pellet weight, pellet shape, temperature, elevation, as well as other factors.

1070fps POWER!
with Lead Pellets

QuietEnergy Series



Serious. Solid. Impact

FLASH W



QUATTRO
TRIGGER

**FULLY SHROUDED
BARREL**



FLASH W-QE

QuietEnergy Version
QE fully shrouded barrel and
Integrated Sound Moderator -
Approximately 50% Quieter.



(*) Scope sold separately



Single shot adapter is included.

| Model | Flash W | | | Flash W-QE | | |
|--|------------------|-----------------|-----------------|------------------|-----------------|-----------------|
| Caliber | 4.5mm / .177cal | 5.5mm / .22cal | 6.35mm / .25cal | 4.5mm / .177cal | 5.5mm / .22cal | 6.35mm / .25cal |
| Max. Muzzle Velocity (*) | 325m/s (1070fps) | 295m/s (970fps) | 265m/s (870fps) | 325m/s (1070fps) | 295m/s (970fps) | 265m/s (870fps) |
| Energy (*) | Joules | 30 | 42 | 46 | 30 | 42 |
| | ft.lbs | 22 | 31 | 34 | 22 | 31 |
| Magazine Capacity | 14 | 12 | 10 | 14 | 12 | 10 |
| Air Tube Volume | 165cc | | | 165cc | | |
| Fill Pressure | 200 BAR | | | 200 BAR | | |
| Number of Shots per fill | 100 | 95 | 90 | 100 | 95 | 90 |
| Number of Shots at Optimal Velocity | 48 | 40 | 38 | 48 | 40 | 38 |
| Stock | Turkish walnut | | | Turkish walnut | | |
| Overall Length | 915mm (36") | | | 1075mm (42.3") | | |
| Barrel Length | 450mm (17.7") | | | 450mm (17.7") | | |
| Weight | 2.82kg (6.2lbs) | | | 3.00kg (6.6lbs) | | |

* Velocity results may vary as much as 20% due to pellet weight, pellet shape, temperature, elevation, as well as other factors.



Serious. Solid. Impact

QuietEnergy Series

1070fps POWER!
with Lead Pellets

FLASH 101



QUATTRO
TRIGGER



FULLY SHROUDED
BARREL



FLASH 101 QE



QuietEnergy Version
QE fully shrouded barrel and
Integrated Sound Moderator -
Approximately 50% Quieter.



Single shot adapter is included.

| Model | Hatsan Flash 101 | | | Hatsan Flash 101 QE | | | |
|-------------------------------------|------------------|-----------------|-----------------|---------------------|-----------------|-----------------|----|
| Caliber | 4.5mm / .177cal | 5.5mm / .22cal | 6.35mm / .25cal | 4.5mm / .177cal | 5.5mm / .22cal | 6.35mm / .25cal | |
| Max. Muzzle Velocity (*) | 325m/s (1070fps) | 295m/s (970fps) | 265m/s (870fps) | 325m/s (1070fps) | 295m/s (970fps) | 265m/s (870fps) | |
| Energy (*) | Joules | 30 | 42 | 46 | 30 | 42 | 46 |
| | ft.lbs | 22 | 31 | 34 | 22 | 31 | 34 |
| Magazine Capacity | 14 | 12 | 10 | 14 | 12 | 10 | |
| Air Tube Volume | 215 cc | | | 215 cc | | | |
| Fill Pressure | 200 BAR | | | 200 BAR | | | |
| Number of Shots per fill | 145 | 140 | 135 | 145 | 140 | 135 | |
| Number of Shots at Optimal Velocity | 55 | 50 | 47 | 55 | 50 | 47 | |
| Stock | Advanced polymer | | | Advanced polymer | | | |
| Overall Length | 915 mm (36") | | | 1090 mm (42,9") | | | |
| Barrel Length | 450mm (17.7") | | | 450mm (17.7") | | | |
| Weight | 3 kg (6.6 lbs) | | | 3.15 kg (6.95 lbs) | | | |

* Velocity results may vary as much as 20% due to pellet weight, pellet shape, temperature, elevation, as well as other factors.

1070fps POWER!
with Lead Pellets

QuietEnergy Series



Serious. Solid. Impact

FLASH 401



QUATTRO
TRIGGER

**FULLY SHROUDED
BARREL**



FLASH 401 QE



QuietEnergy Version
QE fully shrouded barrel and
Integrated Sound Moderator -
Approximately 50% Quieter.

(* Scope sold separately)



Single shot adapter is included.

| Model | Hatsan Flash 401 | | | Hatsan Flash 401 QE | | |
|--|------------------|-----------------|-----------------|---------------------|-----------------|-----------------|
| Caliber | 4.5mm / .177cal | 5.5mm / .22cal | 6.35mm / .25cal | 4.5mm / .177cal | 5.5mm / .22cal | 6.35mm / .25cal |
| Max. Muzzle Velocity (*) | 325m/s (1070fps) | 295m/s (970fps) | 265m/s (870fps) | 325m/s (1070fps) | 295m/s (970fps) | 265m/s (870fps) |
| Energy (*) | Joules | 30 | 42 | 46 | 30 | 42 |
| | ft.lbs | 22 | 31 | 34 | 22 | 31 |
| Magazine Capacity | 14 | 12 | 10 | 14 | 12 | 10 |
| Air Tube Volume | 400 cc | | | 400 cc | | |
| Fill Pressure | 200 BAR | | | 200 BAR | | |
| Number of Shotsper fill | 310 | 300 | 280 | 310 | 300 | 280 |
| Number of Shots at Optimal Velocity | 110 | 105 | 95 | 110 | 105 | 95 |
| Stock | Wood stock | | | Wood stock | | |
| Overall Length | 1015mm (40") | | | 1100 mm (43.3") | | |
| Barrel Length | 450mm (17.7") | | | 450mm (17.7") | | |
| Weight | 3.2 kg (7 lbs) | | | 3.25 kg (7.2 lbs) | | |

(* Velocity results may vary as much as 20% due to pellet weight pellet shape, temperature, elevation, as well as other factors.



Serious. Solid. Impact

QuietEnergy Series

1070fps POWER!
with Lead Pellets

FLASHPUP



FULLY SHROUDED
BARREL



FLASHPUP QE



QuietEnergy Version
QE fully shrouded barrel and
Integrated Sound Moderator -
Approximately 50% Quieter.

Bullpup design, manual loading, side bolt action, pre-charged pneumatic (PCP) air rifle. Precision rifled choked barrel for accuracy, threaded for 1/2" UNF sound moderator & fitted muzzle cap. 165cc volume aluminum air cylinder tube (not detachable) Patented anti-knock system to prevent gas wastage when rifle is knocked or bounced. Manual safety. Quattro Trigger: 2-stage full adjustable match trigger for trigger travel and trigger load. Black metal trigger.



Single shot adapter is included.

| Model | FlashPup | | | FlashPupQE | | |
|-------------------------------------|---|-----------------|-----------------|---|-----------------|-----------------|
| Caliber | 4.5mm / .177cal | 5.5mm / .22cal | 6.35mm / .25cal | 4.5mm / .177cal | 5.5mm / .22cal | 6.35mm / .25cal |
| Max. Muzzle Velocity (*) | 325m/s (1070fps) | 295m/s (970fps) | 265m/s (870fps) | 325m/s (1070fps) | 295m/s (970fps) | 265m/s (870fps) |
| Energy (*) | Joules | 30 | 42 | 46 | 30 | 42 |
| | ft. lbs | 22 | 31 | 34 | 22 | 31 |
| Magazine Capacity | 14 | 12 | 10 | 14 | 12 | 10 |
| Air Tube Volume | 165cc | | | 165cc | | |
| Fill Pressure | 200 BAR | | | 200 BAR | | |
| Number of Shots per fill | 100 | 95 | 90 | 100 | 95 | 90 |
| Number of Shots at Optimal Velocity | 48 | 40 | 38 | 48 | 40 | 38 |
| Stock | Ambidextrous bullpup wooden stock. Elevation adjustable comb. | | | Ambidextrous bullpup wooden stock. Elevation adjustable comb. | | |
| Overall Length | 645mm (25.4") | | | 815mm (32") | | |
| Barrel Length | 450mm (17.7") | | | 450mm (17.7") | | |
| Weight | 2.73kg (6lbs) | | | 2.9kg (6.4lbs) | | |

* Velocity results may vary as much as 20% due to pellet weight, pellet shape, temperature, elevation, as well as other factors.

1070fps POWER!
with Lead Pellets

QuietEnergy Series



Serious. Solid. Impact

FLASHPUP S



**FULLY SHROUDED
BARREL**



FLASHPUP S-QE



QuietEnergy Version
QE fully shrouded barrel and
Integrated Sound Moderator -
Approximately 50% Quieter.

Bullpup design, manual loading, side lever action, pre-charged pneumatic (PCP) air rifle. Precision rifled choked barrel for accuracy, threaded for 1/2" UNF sound moderator & fitted muzzle cap. 165cc volume steel air cylinder tube (not detachable) Patented anti-knock system to prevent gas wastage when rifle is knocked or bounced. Quattro Trigger: 2-stage full adjustable match trigger for trigger travel and trigger load. Black metal trigger.



Single shot adapter is included.

| Model | FlashPup-S | | | FlashPup-S QE | | |
|--|--|-----------------|-----------------|--|-----------------|-----------------|
| Caliber | 4.5mm / .177cal | 5.5mm / .22cal | 6.35mm / .25cal | 4.5mm / .177cal | 5.5mm / .22cal | 6.35mm / .25cal |
| Max. Muzzle Velocity (*) | 325m/s (1070fps) | 295m/s (970fps) | 265m/s (870fps) | 325m/s (1070fps) | 295m/s (970fps) | 265m/s (870fps) |
| Energy (*) | Joules | 30 | 42 | 46 | 30 | 42 |
| | ft.lbs | 22 | 31 | 34 | 22 | 31 |
| Magazine Capacity | 14 | 12 | 10 | 14 | 12 | 10 |
| Air Tube Volume | 165cc | | | 165cc | | |
| Fill Pressure | 200 BAR | | | 200 BAR | | |
| Number of Shots per fill | 100 | 95 | 90 | 100 | 95 | 90 |
| Number of Shots at Optimal Velocity | 48 | 40 | 38 | 48 | 40 | 38 |
| Stock | Ambidextrous bullpup synthetic stock. Elevation adjustable comb. | | | Ambidextrous bullpup synthetic stock. Elevation adjustable comb. | | |
| Overall Length | 645mm (25.4") | | | 815mm (32") | | |
| Barrel Length | 450mm (17.7") | | | 450mm (17.7") | | |
| Weight | 3 kg (6.6lbs) | | | 3.19kg (7lbs) | | |

*Velocity results may vary as much as 20% due to pellet weight, pellet shape, temperature, elevation, as well as other factors.

GLADIUS

**FULLY SHROUDED
BARREL**



QuietEnergy Version
QE fully shrouded barrel and
Integrated Sound Moderator -
Approximately 50% Quieter.

QUATTRO
TRIGGER



GLADIUS OD
OD Green Stock version.



GLADIUS DZ
DZ Color Stock version.



Custom hard case included.



GLADIUS M1
M1 Camo Stock version.



GLADIUS M2
M2 Camo Stock version.



GLADIUS FDE
Flat Dark Earth Color Stock version.

Genuine bullpup design, 10- shot, manual loading, side lever action, pre-charged pneumatic (PCP) air rifle. 6 level power adjustment. Power setting can be done at a turn of the power adjustment knob. Detachable aluminum air cylinder tube (255cc). Spare cylinders

are available. "Anti-double pellet feed" mechanism preventing more than one pellet loading into barrel. Patented anti-knock system to prevent gas wastage when rifle is knocked or bounced. Quattro Trigger: 2-stage full adjustable match trigger for trigger travel and trigger load. Metal trigger. Spare air cylinders with regulator are available. Long version available (Gladius Long) with 585mm barrel and 100 fps (30 m/s) more muzzle velocity.

| Model | Gladius | | | Gladius Long | | |
|-------------------------------------|--|-----------------|-----------------|--|------------------|-----------------|
| Caliber | 4.5mm / .177cal | 5.5mm / .22cal | 6.35mm / .25cal | 4.5mm / .177cal | 5.5mm / .22cal | 6.35mm / .25cal |
| Max. Muzzle Velocity (*) | 325m/s (1070fps) | 295m/s (970fps) | 265m/s (870fps) | 355m/s (1170fps) | 325m/s (1070fps) | 295m/s (970fps) |
| Energy (*) | Joules | 30 | 42 | 46 | 36 | 51 |
| | ft. lbs | 22 | 31 | 34 | 27 | 38 |
| Magazine Capacity | 10 | 10 | 9 | 10 | 10 | 9 |
| Air Tube Volume | 255cc | | | 255cc | | |
| Fill Pressure | 200 BAR | | | 200 BAR | | |
| Number of Shots Per Fill | 120 | 115 | 105 | 120 | 110 | 100 |
| Number of Shots at Optimal Velocity | 65 | 60 | 50 | 60 | 50 | 45 |
| Stock | Bullpup, advanced polymer, thumbhole, elevation adjustable comb, adjustable butt bad | | | Bullpup, advanced polymer, thumbhole, elevation adjustable comb, adjustable butt bad | | |
| Overall Length | 875mm (34.4") | | | 965mm (38") | | |
| Barrel Length | 495mm (19.4") | | | 585mm (23") | | |
| Weight | 4.65kg (10.2lbs) | | | 4.8kg (10.6lbs) | | |

* Velocity results may vary as much as 20% due to pellet weight, pellet shape, temperature, elevation, as well as other factors. * Above maximum velocity and energy figures are at power adjustment level 6.

| Power Setting | Gladius Average Energy 4.5mm / .177cal | Gladius Long Average Energy 4.5mm / .177cal |
|---------------|---|--|
| 6 | 30 Joule | 36 Joule |
| 5 | 26 Joule | 30 Joule |
| 4 | 22 Joule | 26,5 Joule |
| 3 | 17 Joule | 21,5 Joule |
| 2 | 12 Joule | 15 Joule |
| 1 | 7 Joule | 8,5 Joule |

| Power Setting | Gladius Average Energy 5.5mm / .22cal | Gladius Long Average Energy 5.5mm / .22cal |
|---------------|--|---|
| 6 | 42 Joule | 51 Joule |
| 5 | 36 Joule | 42 Joule |
| 4 | 31 Joule | 36 Joule |
| 3 | 24 Joule | 28 Joule |
| 2 | 16 Joule | 19 Joule |
| 1 | 10 Joule | 11.5 Joule |

| Power Setting | Gladius Average Energy 6.35mm / .25cal | Gladius Long Average Energy 6.35mm / .25cal |
|---------------|---|--|
| 6 | 46 Joule | 57 Joule |
| 5 | 39 Joule | 46 Joule |
| 4 | 33 Joule | 39 Joule |
| 3 | 25 Joule | 29 Joule |
| 2 | 17,5 Joule | 20 Joule |
| 1 | 10 Joule | 12 Joule |

1170fps POWER!
with Lead Pellets

QuietEnergy Series



BULLBOSS

QuietEnergy Series

**FULLY SHROUDED
BARREL**



QuietEnergy Version
QE fully shrouded barrel and
Integrated Sound Moderator -
Approximately 50% Quieter.



BULLBOSS W
Wooden Stock version.



BULLBOSS OD
OD Green Stock version.



BULLBOSS DZ
DZ Color Stock version.



BULLBOSS FDE
Flat Dark Earth Color Stock version.



BULLBOSS M1
M1 Camo Stock version.



BULLBOSS M2
M2 Camo Stock version.

| Model | BullBoss | | |
|-------------------------------------|---|------------------|-----------------|
| Caliber | 4.5mm / .177cal | 5.5mm / .22cal | 6.35mm / .25cal |
| Max. Muzzle Velocity (*) | 355m/s (1170fps) | 325m/s (1070fps) | 295m/s (970fps) |
| Energy (*) | Joules | 36 | 51 |
| | ft. lbs | 27 | 38 |
| Magazine Capacity | 10 | 10 | 9 |
| Air Tube Volume | 230cc | | |
| Fill Pressure | 200 BAR | | |
| Number of Shots Per Fill | 160 | 150 | 135 |
| Number of Shots at Optimal Velocity | 55 | 45 | 45 |
| Stock | Bullpup, advanced polymer, thumbhole, elevation adjustable comb | | |
| Overall Length | 935mm (36.8") | | |
| Barrel Length | 585 mm (23") | | |
| Weight | 4.3 kg (9.5lbs) | | |

- Side lever action.
- Picatinny rail for both 11 mm and 22 mm scope mounts.
- Quattro Trigger
- Detachable 10-shot magazine in .177 (4.5 mm) and .22 (5.5 mm) calibers and 9-shot magazine in 25 (6.35 mm) caliber.



*Velocity results may vary as much as 20% due to pellet weight, pellet shape, temperature, elevation, as well as other factors.



Serious. Solid. Impact

QuietEnergy Series

1250fps POWER!
with Lead Pellets

BT65SB & RB & QE



BT65 SB
Side Bolt version



BT65 RB
Rear Bolt version

**FULLY SHROUDED
BARREL**



BT65 SB QE
Side Bolt version



BT65RB QE
Rear Bolt version

- Side bolt action or rear bolt action.
- Manual Safety.
- Scope mount rail for both 11mm and 22mm scope mounts.
- 10-shot magazine (9-shot magazine in .25/6.35mm caliber)
- Micro adjustable rear sight with Truglo fiber optics.
- Quattro Trigger: 2-stage full adjustable match trigger for trigger travel and trigger load.
- Gold plated trigger blade.



| Model | BT65 SB (Side Bolt) BT65 RB (Rear Bolt) | | |
|------------------------------|--|---------------------|------------------|
| Caliber | 4.5mm / .177cal | 5.5mm / .22cal | 6.35mm / .25cal |
| Max. Muzzle Velocity (*) | 380m/s (1250fps) | 360m/s (1180fps) | 330m/s (1090fps) |
| Energy (*) | Joules | 40 | 61 |
| | ft. lbs | 30 | 45 |
| Magazine Capacity | 10 | 10 | 9 |
| Air Tube Volume | 255cc | | |
| Fill Pressure | 200 BAR | | |
| Shots Per Fill | 70 | 70 | 65 |
| Shots at Optimal Velocity | 30 | 28 | 25 |
| Stock | Advanced polymer, montecarlo cheekpiece, adjustable butt pad & adjustable comb | | |
| Overall Length | 1080mm (42.5") | | |
| Barrel Length | 585mm (23") | | |
| Weight | 4.1kg (9lbs) | | |
| Fiber Optic Sights Diameters | Rear Sight | 0.9mm (.035") green | |
| | Front Sight | 1.5mm (.060") red | |

| Model | BT65SB-QE (Side Bolt) BT65RB-QE (Rear Bolt) | | |
|---------------------------|---|------------------|------------------|
| Caliber | 4.5mm / .177cal | 5.5mm / .22cal | 6.35mm / .25cal |
| Max. Muzzle Velocity (*) | 380m/s (1250fps) | 360m/s (1180fps) | 330m/s (1090fps) |
| Energy | Joules | 40 | 61 |
| | ft. lbs | 30 | 45 |
| Magazine Capacity | 10 | 10 | 9 |
| Air Tube Volume | 255cc | | |
| Fill Pressure | 200 BAR | | |
| Shots Per Fill | 70 | 70 | 65 |
| Shots at Optimal Velocity | 30 | 28 | 25 |
| Stock | Advanced polymer, thumbhole, montecarlo cheekpiece, adjustable butt pad & adjustable comb | | |
| Overall Length | 1240mm (48.8") | | |
| Barrel Length | 585mm (23") | | |
| Weight | 4.4kg (9.7lbs) | | |

* Velocity results may vary as much as 20% due to pellet weight, pellet shape, temperature, elevation, as well as other factors.

1250fps POWER!
with Lead Pellets

QuietEnergy Series



BT65SB & RB ELITE

(* Scope included with BT65SB & RB ELITE)



BT65SB-ELITE
Side Bolt version



BT65RB-ELITE
Rear Bolt version

**FULLY SHROUDED
BARREL**



BT65SB-ELITE QE
Side Bolt version



BT65RB-ELITE QE
Rear Bolt version

- Side bolt action or rear bolt action.
- Auto / Manual Safety.
- Scope mount rail good for both 11mm and 22mm scope mounts.
- 10-shot magazine (9-shot magazine in .25 /6.35mm caliber).
- Quattro Trigger: 2-stage full adjustable match trigger for trigger travel and trigger load.
- Gold plated trigger blade.



| Model | BT65SB-Elite (Side Bolt) BT65RB-Elite (Rear Bolt) | | | Model | BT65SB Elite -QE (Side Bolt) BT65RB Elite -QE (Rear Bolt) | | |
|------------------------------|---|---------------------|------------------|------------------------------|---|---------------------|------------------|
| Caliber | 4.5mm / .177cal | 5.5mm / .22cal | 6.35mm / .25cal | Caliber | 4.5mm / .177cal | 5.5mm / .22cal | 6.35mm / .25cal |
| Max. Muzzle Velocity (*) | 380m/s (1250fps) | 360m/s (1180fps) | 330m/s (1090fps) | Max. Muzzle Velocity (*) | 380m/s (1250fps) | 360m/s (1180fps) | 330m/s (1090fps) |
| Energy (*) | Joules | 40 | 61 | Energy | Joules | 40 | 61 |
| | ft. lbs | 30 | 45 | | ft. lbs | 30 | 45 |
| Magazine Capacity | 10 | 10 | 9 | Magazine Capacity | 10 | 10 | 9 |
| Air Tube Volume | 255cc | | | Air Tube Volume | 255cc | | |
| Fill Pressure | 200 BAR | | | Fill Pressure | 200 BAR | | |
| Shots Per Fill | 70 | 70 | 65 | Shots Per Fill | 70 | 70 | 65 |
| Shots at Optimal Velocity | 30 | 28 | 25 | Shots at Optimal Velocity | 30 | 28 | 25 |
| Stock | Advanced polymer, thumbhole, montecarlo cheekpiece, adjustable butt pad & adjustable comb | | | Stock | Advanced polymer, thumbhole, montecarlo cheekpiece, adjustable butt pad & adjustable comb | | |
| Overall Length | 1080mm (42.5") | | | Overall Length | 1240mm (48.8") | | |
| Barrel Length | 585mm (23") | | | Barrel Length | 585mm (23") | | |
| Weight | 4.23kg (9.3lbs) | | | Weight | 4.4kg (9.7lbs) | | |
| Fiber Optic Sights Diameters | Rear Sight | 0.9mm (.035") green | | Fiber Optic Sights Diameters | Rear Sight | 0.9mm (.035") green | |
| | Front Sight | 1.5mm (.060") red | | | Front Sight | 1.5mm (.060") red | |

* Velocity results may vary as much as 20% due to pellet weight, pellet shape, temperature, elevation, as well as other factors.



Serious. Solid. Impact

1250fps POWER!
with Lead Pellets

BT65SB-W



BT65SB-W
Side bolt version



BT65RB-W
Rear bolt version

Elevation adjustable comb. Stock length of pull, elevation & fit angle adjustable rubber butt pad.



| Model | | BT65 SB-W (Side Bolt) / BT65 RB-W (Rear Bolt) | | |
|------------------------------|-------------|--|------------------|------------------|
| Caliber | | 4.5mm / .177cal | 5.5mm / .22cal | 6.35mm / .25cal |
| Max. Muzzle Velocity (*) | | 380m/s (1250fps) | 360m/s (1180fps) | 330m/s (1090fps) |
| Energy (*) | Joules | 40 | 61 | 71 |
| | ft. lbs | 30 | 45 | 52 |
| Magazine Capacity | | 10 | 10 | 9 |
| Air Tube Volume | | 255cc | | |
| Fill Pressure | | 200 BAR | | |
| Shots Per Fill | | 70 | 70 | 65 |
| Shots at Optimal Velocity | | 30 | 28 | 25 |
| Stock | | Genuine Turkish walnut, montecarlo cheekpiece, adjustable butt pad & adjustable comb | | |
| Overall Length | | 1080mm (42.5") | | |
| Barrel Length | | 585mm (23") | | |
| Weight | | 4.3kg (9.4lbs) | | |
| Fiber Optic Sights Diameters | Rear Sight | 0.9mm (.035") green | | |
| | Front Sight | 1.5mm (.060") red | | |

- Side bolt action or rear bolt action.
- Manual Safety
- Scope mount rail for both 11mm and 22mm scope mounts
- 10-shot magazine (9-shot magazine in .25 / 6.35mm caliber)
- Micro adjustable rear sight with Truglo fiber optics



- Quattro Trigger: 2-stage full adjustable match trigger for trigger travel and trigger load.
- Gold plated trigger blade

* Velocity results may vary as much as 20% due to pellet weight, pellet shape, temperature, elevation, as well as other factors.

1190fpsPOWER!
with Lead Pellets

QuietEnergySeries



Serious. Solid. Impact

GALATIAN I



- Removable rear sight.
- Trigger lock included.



**FULLY SHROUDED
BARREL**



GALATIAN I-CARBINE

Shorter (carbine) barrel version. QuietEnergy fully shrouded barrel and Integrated Sound Moderator - Approximately 50% Quieter. (50-60fps less velocity due to carbine barrel)



- Side lever action
- Cocking indicator
- Dovetail grooved receiver for 11mm or 22mm scope mounts
- Quattro trigger
- Micro adjustable rear sight with Truglo fiber optics.
- Detachable 16-shot magazine in .177 caliber, 14-shot magazine in .22 and 13-shot magazine in .25



- Elevation adjustable comb. Stock length of pull, elevation & fit angle adjustable rubber butt pad.
- Spare magazine carrying slot in the stock

| Model | Galatian I | | | Galatian I Carbine | | | |
|------------------------------|--|---------------------|------------------|--|------------------|-----------------|--|
| Caliber | 4.5mm / .177cal | 5.5mm / .22cal | 6.35mm / .25cal | 4.5mm / .177cal | 5.5mm / .22cal | 6.35mm / .25cal | |
| Max. Muzzle Velocity (*) | 360m/s (1190fps) | 333m/s (1100fps) | 303m/s (1000fps) | 342m/s (1130fps) | 318m/s (1050fps) | 287m/s (950fps) | |
| Energy | Joules | 37 | 53 | 60 | 33 | 49 | |
| | ft. lbs | 27 | 39 | 44 | 24 | 36 | |
| Magazine Capacity | 16 | 14 | 13 | 16 | 14 | 13 | |
| Air Tube Volume | 255cc | | | 255cc | | | |
| Fill Pressure | 200 BAR | | | 200 BAR | | | |
| Shots Per Fill | 100 | 90 | 80 | 100 | 90 | 80 | |
| Shots at Optimal Velocity | 45 | 40 | 36 | 45 | 40 | 36 | |
| Stock | High Quality Turkish Walnut Thumbhole, Adjustable Butt Pad & Adjustable Comb | | | High Quality Turkish Walnut Thumbhole, Adjustable Butt Pad & Adjustable Comb | | | |
| Overall Length | 1075mm (42.3") | | | 1100mm (43.3") | | | |
| Barrel Length | 585mm (23") | | | 450mm (17.7") | | | |
| Weight | 4kg (8.8lbs) | | | 3.9kg (8.6lbs) | | | |
| Fiber Optic Sights Diameters | Rear Sight | 0.9mm (.035") green | | | No sights | | |
| | Front Sight | 1.5mm (.060") red | | | No sights | | |

* Velocity results may vary as much as 20% due to pellet weight, pellet shape, temperature, elevation, as well as other factors.

GALATIAN II - III - IV



| Model | | Galatian II | | |
|-------------------------------------|--------------------|--|------------------|------------------|
| Caliber | | 4.5mm / .177cal | 5.5mm / .22cal | 6.35mm / .25cal |
| Max. Muzzle Velocity (*) | | 360m/s (1190fps) | 333m/s (1100fps) | 303m/s (1000fps) |
| Energy | Joules | 37 | 53 | 60 |
| | ft. lbs | 27 | 39 | 44 |
| Magazine Capacity | | 16 | 14 | 13 |
| Air Tube Volume | | 255cc | | |
| Fill Pressure | | 200 BAR | | |
| Shots Per Fill | | 100 | 90 | 80 |
| Shots at Optimal Velocity | | 45 | 40 | 36 |
| Stock | | High Quality Turkish Walnut Adjustable Butt Pad & Adjustable Comb | | |
| Overall Length | | 1075mm (42.3") | | |
| Barrel Length | | 585mm (23") | | |
| Weight | | 3.9kg (8.6lbs) | | |
| Fiber Optic Sights Diameters | Rear Sight | 0.9mm (.035") green | | |
| | Front Sight | 1.5mm (.060") red | | |

| Model | | Galatian III | | |
|-------------------------------------|--------------------|---|------------------|------------------|
| Caliber | | 4.5mm / .177cal | 5.5mm / .22cal | 6.35mm / .25cal |
| Max. Muzzle Velocity (*) | | 360m/s (1190fps) | 333m/s (1100fps) | 303m/s (1000fps) |
| Energy | Joules | 37 | 53 | 60 |
| | ft. lbs | 27 | 39 | 44 |
| Magazine Capacity | | 16 | 14 | 13 |
| Air Tube Volume | | 255cc | | |
| Fill Pressure | | 200 BAR | | |
| Shots Per Fill | | 100 | 90 | 80 |
| Shots at Optimal Velocity | | 45 | 40 | 36 |
| Stock | | Advanced Polymer, Thumbhole, Adjustable Butt Pad & Adjustable Comb | | |
| Overall Length | | 1075mm (42.3") | | |
| Barrel Length | | 585mm (23") | | |
| Weight | | 4.2kg (9.2lbs) | | |
| Fiber Optic Sights Diameters | Rear Sight | 0.9mm (.035") green | | |
| | Front Sight | 1.5mm (.060") red | | |

| Model | | Galatian IV | | |
|-------------------------------------|--------------------|--|------------------|------------------|
| Caliber | | 4.5mm / .177cal | 5.5mm / .22cal | 6.35mm / .25cal |
| Max. Muzzle Velocity (*) | | 360m/s (1190fps) | 333m/s (1100fps) | 303m/s (1000fps) |
| Energy | Joules | 37 | 53 | 60 |
| | ft. lbs | 27 | 39 | 44 |
| Magazine Capacity | | 16 | 14 | 13 |
| Air Tube Volume | | 255cc | | |
| Fill Pressure | | 200 BAR | | |
| Shots Per Fill | | 100 | 90 | 80 |
| Shots at Optimal Velocity | | 45 | 40 | 36 |
| Stock | | Advanced Polymer, Adjustable Butt Pad & Adjustable Comb | | |
| Overall Length | | 1075mm (42.3") | | |
| Barrel Length | | 585mm (23") | | |
| Weight | | 4.15kg (9.1lbs) | | |
| Fiber Optic Sights Diameters | Rear Sight | 0.9mm (.035") green | | |
| | Front Sight | 1.5mm (.060") red | | |

*Velocity results may vary as much as 20% due to pellet weight, pellet shape, temperature, elevation, as well as other factors.



GALATIAN II-CARBINE

GALATIAN III-CARBINE

GALATIAN IV-CARBINE

Shorter (carbine) barrel version. QuietEnergy fully shrouded barrel and Integrated Sound Moderator - Approximately 50% Quieter. (50-60fps less velocity due to carbine barrel)

| Model | | Galatian II Carbine | | |
|---------------------------|-------------|--|------------------|-----------------|
| Caliber | | 4.5mm / .177cal | 5.5mm / .22cal | 6.35mm / .25cal |
| Max. Muzzle Velocity (*) | | 342m/s (1130fps) | 318m/s (1050fps) | 287m/s (950fps) |
| Energy | Joules | 33 | 49 | 54 |
| | ft. lbs | 24 | 36 | 40 |
| Magazine Capacity | | 16 | 14 | 13 |
| Air Tube Volume | | 255cc | | |
| Fill Pressure | | 200 BAR | | |
| Shots Per Fill | | 100 | 90 | 80 |
| Shots at Optimal Velocity | | 45 | 40 | 36 |
| Stock | | High Quality Turkish Walnut Adjustable Butt Pad & Adjustable Comb | | |
| Overall Length | | 1100mm (43.3") | | |
| Barrel Length | | 450mm (17.7") | | |
| Weight | | 3.8kg (8.4lbs) | | |
| Fiber Optic | Rear Sight | No Sights | | |
| Sights Diameters | Front Sight | No Sights | | |

| Model | | Galatian III Carbine | | |
|---------------------------|-------------|---|------------------|-----------------|
| Caliber | | 4.5mm / .177cal | 5.5mm / .22cal | 6.35mm / .25cal |
| Max. Muzzle Velocity (*) | | 342m/s (1130fps) | 318m/s (1050fps) | 287m/s (950fps) |
| Energy | Joules | 33 | 49 | 54 |
| | ft. lbs | 24 | 36 | 40 |
| Magazine Capacity | | 16 | 14 | 13 |
| Air Tube Volume | | 255cc | | |
| Fill Pressure | | 200 BAR | | |
| Shots Per Fill | | 100 | 90 | 80 |
| Shots at Optimal Velocity | | 45 | 40 | 36 |
| Stock | | Advanced Polymer, Thumbhole, Adjustable Butt Pad & Adjustable Comb | | |
| Overall Length | | 1100mm (43.3") | | |
| Barrel Length | | 450mm (17.7") | | |
| Weight | | 4.1kg (9lbs) | | |
| Fiber Optic | Rear Sight | No Sights | | |
| Sights Diameters | Front Sight | No Sights | | |

| Model | | Galatian IV Carbine | | |
|---------------------------|-------------|--|------------------|-----------------|
| Caliber | | 4.5mm / .177cal | 5.5mm / .22cal | 6.35mm / .25cal |
| Max. Muzzle Velocity (*) | | 342m/s (1130fps) | 318m/s (1050fps) | 287m/s (950fps) |
| Energy | Joules | 33 | 49 | 54 |
| | ft. lbs | 24 | 36 | 40 |
| Magazine Capacity | | 16 | 14 | 13 |
| Air Tube Volume | | 255cc | | |
| Fill Pressure | | 200 BAR | | |
| Shots Per Fill | | 100 | 90 | 80 |
| Shots at Optimal Velocity | | 45 | 40 | 36 |
| Stock | | Advanced Polymer, Adjustable Butt Pad & Adjustable Comb | | |
| Overall Length | | 1100mm (43.3") | | |
| Barrel Length | | 450mm (17.7") | | |
| Weight | | 4.05kg (8.9lbs) | | |
| Fiber Optic | Rear Sight | No Sights | | |
| Sights Diameters | Front Sight | No Sights | | |

* Velocity results may vary as much as 20% due to pellet weight, pellet shape, temperature, elevation, as well as other factors.



Serious. Solid. Impact

1070fps POWER!
with Lead Pellets

AT44-10 TACT



Telescopic stock can be removed, allowing the use with pistol grip only.

- Manual & Auto Safety.
- Scope mount rail good for both 11 mm and 22 mm scope mounts
- 10-shot magazine (9-shot magazine in .25 /6.35mm caliber)
- Micro adjustable rear sight

| Model | AT44-10 Tact QE | | | AT44-10 Tact Long QE | | | |
|----------------------------------|---|-----------------|-----------------|---|------------------|-----------------|--|
| Caliber | 4.5mm / .177cal | 5.5mm / .22cal | 6.35mm / .25cal | 4.5mm / .177cal | 5.5mm / .22cal | 6.35mm / .25cal | |
| Max. Muzzle Velocity (*) | 325m/s (1070fps) | 295m/s (970fps) | 265m/s (870fps) | 355m/s (1170fps) | 325m/s (1070fps) | 295m/s (970fps) | |
| Energy | Joules | 30 | 42 | 46 | 36 | 51 | |
| | ft. lbs | 22 | 31 | 34 | 27 | 38 | |
| Magazine Capacity | 10 | 10 | 9 | 10 | 10 | 9 | |
| Air Tube Volume | 180cc | | | 230cc | | | |
| Fill Pressure | 200 BAR | | | 200 BAR | | | |
| Shots Per Fill | 115 | 110 | 95 | 115 | 110 | 95 | |
| Shots at Optimal Velocity | 60 | 55 | 45 | 55 | 50 | 40 | |
| Stock | Tactical Telescopic Stock / Adjustable Comb Advanced Polymer Grip | | | Tactical Telescopic Stock / Adjustable Comb Advanced Polymer Grip | | | |
| Overall Length | Butt Shortened | 1045mm (41") | | | 1135 (44.6") | | |
| | Butt Extended | 1145mm (45") | | | 1235 (48.6") | | |
| Barrel Length | 495mm (19.4") | | | 585mm (23") | | | |
| Weight | 4.3kg (9.5lbs) | | | 4.7kg (10.4lbs) | | | |

* Velocity results may vary as much as 20% due to pellet weight, pellet shape, temperature, elevation, as well as other factors.

1070fps POWER!
with Lead Pellets

QuietEnergy Series



Serious. Solid. Impact



Fitted detachable telescopic stock. Stock can be shortened/extended by 10cm (4"). Elevation adjustable comb - easily adjusted by a coin.

- Manual & Auto Safety.
- Scope mount rail good for both 11 mm and 22 mm scope mounts
- 10-shot magazine (9-shot magazine in .25/6.35mm caliber)
- Micro adjustable rear sight



- Quattro Trigger: 2-stage full adjustable match trigger for trigger travel and trigger load.
- Gold plated trigger blade



FULLY SHROUDED BARREL



AT44-10 TACT QE



QuietEnergy Version
QE fully shrouded barrel and Integrated Sound Moderator - Approximately 50% Quieter.

| Model | AT44-10 Tact | | | AT44-10 Tact Long | | | |
|------------------------------|---|---------------------|-----------------|---|------------------|-----------------|--|
| Caliber | 4.5mm / .177cal | 5.5mm / .22cal | 6.35mm / .25cal | 4.5mm / .177cal | 5.5mm / .22cal | 6.35mm / .25cal | |
| Max. Muzzle Velocity (*) | 325m/s (1070fps) | 295m/s (970fps) | 265m/s (870fps) | 355m/s (1170fps) | 325m/s (1070fps) | 295m/s (970fps) | |
| Energy | Joules | 30 | 42 | 46 | 36 | 51 | |
| | ft.lbs | 22 | 31 | 34 | 27 | 38 | |
| Magazine Capacity | 10 | 10 | 9 | 10 | | | |
| Air Tube Volume | 180cc | | | 230cc | | | |
| Fill Pressure | 200 BAR | | | 200 BAR | | | |
| Shots Per Fill | 115 | 110 | 95 | 115 | 110 | 95 | |
| Shots at Optimal Velocity | 60 | 55 | 45 | 55 | 50 | 40 | |
| Stock | Tactical Telescopic Stock / Adjustable Comb / Advanced Polymer Grip | | | Tactical Telescopic Stock / Adjustable Comb / Advanced Polymer Grip | | | |
| Overall Length | Butt Shortened | 885mm (34.8") | | | 980mm (38.6") | | |
| | Butt Extended | 985mm (38.8") | | | 1080mm (42.5") | | |
| Barrel Length | 495mm (19.4") | | | 585mm (23") | | | |
| Weight | 3.9kg (8.6lbs) | | | 4.3kg (9.5lbs) | | | |
| Fiber Optic Sights Diameters | Rear Sight | 0.9mm (.035") green | | | | | |
| | Front Sight | 1.5mm (.060") red | | | | | |

*Velocity results may vary as much as 20% due to pellet weight, pellet shape, temperature, elevation, as well as other factors.



Serious. Solid. Impact

1070fps POWER!
with Lead Pellets

AT44-10



AT44-10 CAMO

Mossy Oak New Break Up camo version.



AT44-10 MW

Stock luxurious walnut woodgrain camo version.



AT44-10 LONG

Long version with 230cc air cylinder tube, 58cm barrel and 100fps (30m/s) more muzzle velocity. Available in Camo and MW finish versions.

| Model | AT44-10 | | | AT44-10 Long | | |
|---------------------------|--|---------------------|-----------------|------------------|------------------|-----------------|
| Caliber | 4.5mm / .177cal | 5.5mm / .22cal | 6.35mm / .25cal | 4.5mm / .177cal | 5.5mm / .22cal | 6.35mm / .25cal |
| Max. Muzzle Velocity (*) | 325m/s (1070fps) | 295m/s (970fps) | 265m/s (870fps) | 355m/s (1170fps) | 325m/s (1070fps) | 295m/s (970fps) |
| Energy (*) | Joules | 30 | 42 | 46 | 36 | 51 |
| | ft.lbs | 22 | 31 | 34 | 27 | 38 |
| Magazine Capacity | 10 | 10 | 9 | 10 | 10 | 9 |
| Air Tube Volume | 180cc | | | 230cc | | |
| Fill Pressure | 200 BAR | | | | | |
| Shots Per Fill | 115 | 110 | 95 | 115 | 110 | 95 |
| Shots at Optimal Velocity | 60 | 55 | 45 | 55 | 50 | 40 |
| Stock | Advanced polymer, thumbhole, elevation adjustable comb, adjustable butt pad. | | | | | |
| Overall Length | 990mm(39") | | | 1085mm(42.7") | | |
| Barrel Length | 490mm(19.3") | | | 585mm(23") | | |
| Weight | 3.3kg(7.3lbs) | | | 3.70kg(8.1lbs) | | |
| Fiber Optic Sights | Rear Sight | 0.9mm (.035") green | | | | |
| | Front Sight | 1.5mm (.060") red | | | | |

* Velocity results may vary as much as 20% due to pellet weight, pellet shape, temperature, elevation, as well as other factors.

1070fps POWER!
with Lead Pellets

QuietEnergy Series



Serious. Solid. Impact

AT44W-10



**FULLY SHROUDED
BARREL**

AT44W-10 LONG

Long version with 230 cc air cylinder tube, 58 cm barrel and 100 fps (30 m/s) more muzzle velocity.



AT44W-10 QE



QuietEnergy Version
QE fully shrouded barrel and Integrated Sound Moderator - Approximately 50% Quieter.

- Manual & Auto Safety.
- Scope mount rail for both 11 mm and 22 mm scope mounts.
- 10-shot magazine (9-shot magazine in .25/6.35mm caliber)
- Micro adjustable rear sight.



- Quattro Trigger: 2-stage full adjustable match trigger for trigger travel and trigger load.
- Gold plated trigger blade

Elevation & fit angle adjustable rubber butt pad.



| Model | | AT44W-10 | | | AT44W-10 Long | | |
|-------------------------------------|--------------------|---|-----------------|-----------------|---|------------------|-----------------|
| Caliber | | 4.5mm / .177cal | 5.5mm / .22cal | 6.35mm / .25cal | 4.5mm / .177cal | 5.5mm / .22cal | 6.35mm / .25cal |
| Max. Muzzle Velocity (*) | | 325m/s (1070fps) | 295m/s (970fps) | 265m/s (870fps) | 355m/s (1170fps) | 325m/s (1070fps) | 295m/s (970fps) |
| Energy (*) | Joules | 30 | 42 | 46 | 36 | 51 | 57 |
| | ft.lbs | 22 | 31 | 34 | 27 | 38 | 42 |
| Magazine Capacity | | 10 | 10 | 9 | 10 | 10 | 9 |
| Air Tube Volume | | 180cc | | | 230cc | | |
| Fill Pressure | | 200 BAR | | | 200 BAR | | |
| Shots Per Fill | | 115 | 110 | 95 | 115 | 110 | 95 |
| Shots at Optimal Velocity | | 60 | 55 | 45 | 55 | 50 | 40 |
| Stock | | Genuine Turkish walnut, montecarlo cheekpiece, adjustable butt pad. | | | Genuine Turkish walnut, montecarlo cheekpiece, adjustable butt pad. | | |
| Overall Length | | 990mm (39") | | | 1085mm (42.7") | | |
| Barrel Length | | 490mm (19.3") | | | 585mm (23") | | |
| Weight | | 3.6kg (7.9lbs) | | | 4kg (8.8lbs) | | |
| Fiber Optic Sights Diameters | Rear Sight | 0.9mm (.035") green | | | 0.9mm (.035") green | | |
| | Front Sight | 1.5mm (.060") red | | | 1.5mm (.060") red | | |

* Velocity results may vary as much as 20% due to pellet weight, pellet shape, temperature, elevation, as well as other factors.



Serious. Solid. Impact

QuietEnergy Series

1070fps POWER!
with Lead Pellets

AT44-10 QE

FULLY SHROUDED
BARREL



QuietEnergy Version
QE fully shrouded barrel and
Integrated Sound Moderator -
Approximately 50% Quieter.



AT44-10 LONG QE

Long version with 230cc air cylinder tube,
58cm barrel and 100fps (30m/s) more muzzle velocity

- Elevation adjustable comb
- Elevation and fit angle adjustable rubber butt pad



| Model | AT44-10 QE | | | AT44-10 Long QE | | |
|---------------------------|---|-----------------|-----------------|---|------------------|-----------------|
| Caliber | 4.5mm / .177cal | 5.5mm / .22cal | 6.35mm / .25cal | 4.5mm / .177cal | 5.5mm / .22cal | 6.35mm / .25cal |
| Max. Muzzle Velocity (*) | 325m/s (1070fps) | 295m/s (970fps) | 265m/s (870fps) | 355m/s (1170fps) | 325m/s (1070fps) | 295m/s (970fps) |
| Energy | Joules | 30 | 42 | 46 | 36 | 51 |
| | ft. lbs | 22 | 31 | 34 | 27 | 38 |
| Magazine Capacity | 10 | 10 | 9 | 10 | 10 | 9 |
| Air Tube Volume | 180cc | | | 230cc | | |
| Fill Pressure | 200 BAR | | | 200 BAR | | |
| Shots Per Fill | 115 | 110 | 95 | 115 | 110 | 95 |
| Shots at Optimal Velocity | 60 | 55 | 45 | 55 | 50 | 40 |
| Stock | Advanced polymer, thumbhole, elevation adjustable comb adjustable butt pad. | | | Advanced polymer, thumbhole, elevation adjustable comb adjustable butt pad. | | |
| Overall Length | 1155mm (39.4") | | | 1245mm (42.7") | | |
| Barrel Length | 495mm (19.4") | | | 585mm (23") | | |
| Weight | 3.7kg (8.1lbs) | | | 4.10kg (9lbs) | | |

*Velocity results may vary as much as 20% due to pellet weight, pellet shape, temperature, elevation, as well as other factors.

1070fps POWER!
with Lead Pellets



Serious. Solid. Impact

AT44S-10



AT44S-10 CAMO
Mossy Oak New Break Up camo version.



AT44S-10 MW
Stock luxurious walnut woodgrain camo version.



AT44S-10 LONG
Long version with 230cc air cylinder tube, 58cm barrel and 100fps (30m/s) more muzzle velocity. Available in Camo and MW finish versions.

| Model | AT44S-10 | | | AT44S-10 Long | | |
|---------------------------------|---|---------------------|-----------------|------------------|------------------|-----------------|
| Caliber | 4.5mm / .177cal | 5.5mm / .22cal | 6.35mm / .25cal | 4.5mm / .177cal | 5.5mm / .22cal | 6.35mm / .25cal |
| Max. Muzzle Velocity (*) | 325m/s (1070fps) | 295m/s (970fps) | 265m/s (870fps) | 355m/s (1170fps) | 325m/s (1070fps) | 295m/s (970fps) |
| Energy (*) | Joules | 30 | 42 | 46 | 36 | 51 |
| | ft. lbs | 22 | 31 | 34 | 27 | 38 |
| Magazine Capacity | 10 | 10 | 9 | 10 | 10 | 9 |
| Air Tube Volume | 180cc | | | 230cc | | |
| Fill Pressure | 200 BAR | | | | | |
| Shots Per Fill | 115 | 110 | 95 | 115 | 110 | 95 |
| Shots at Optimal Velocity | 60 | 55 | 45 | 55 | 50 | 40 |
| Stock | Advanced polymer, montecarlo cheekpiece, adjustable butt pad. | | | | | |
| Overall Length | 990mm (39") | | | 1085mm (42.7") | | |
| Barrel Length | 490mm (19.3") | | | 585mm (23") | | |
| Weight | 3.2kg (7lbs) | | | 3.6kg (7.9lbs) | | |
| Fiber Optic Sights Diameters | Rear Sight | 0.9mm (.035") green | | | | |
| | Front Sight | 1.5mm (.060") red | | | | |



- Elevation adjustable comb which can be easily adjusted by a coin.
- Elevation & fit angle adjustable rubber butt pad.

* Velocity results may vary as much as 20% due to pellet weight, pellet shape, temperature, elevation, as well as other factors.



Serious. Solid. Impact

1070fps POWER!
with Lead Pellets

VECTIS

Lever-Action

**FULLY SHROUDED
BARREL**



Integrated Sound Moderator
Sound moderator in muzzlebreak for reduced down-range noise

Foldable design rear and front sight. Sights can be detached from the picatinny rail.



Lever action mechanism.

(* Scope sold separately)



Manual loading, lever action, pre-charged pneumatic (PCP) air rifle. Integrated sound moderator. 165cc volume steel air cylinder tube (not detachable) Patented anti-knock system to prevent gas wastage when rifle is knocked or bounced.

| Model | Vectis | | | |
|-------------------------------------|--|-----------------|-----------------|----|
| Caliber | 4.5mm / .177cal | 5.5mm / .22cal | 6.35mm / .25cal | |
| Max. Muzzle Velocity (*) | 325m/s (1070fps) | 295m/s (970fps) | 265m/s (870fps) | |
| Energy (*) | Joules | 30 | 42 | 46 |
| | ft. lbs | 22 | 31 | 34 |
| Magazine Capacity | 14 | 12 | 10 | |
| Air Tube Volume | 165cc | | | |
| Fill Pressure | 200 BAR | | | |
| Number of Shots per fill | 100 | 95 | 90 | |
| Number of Shots at Optimal Velocity | 48 | 40 | 38 | |
| Stock | Advanced polymer, montecarlo cheekpiece. | | | |
| Overall Length | 1050mm (41.3") | | | |
| Barrel Length | 450mm (17.7") | | | |
| Weight | 3.2kg (7.1lbs) | | | |

* Velocity results may vary as much as 20% due to pellet weight, pellet shape, temperature, elevation, as well as other factors.



Serious. Solid. Impact

HATSAN BLITZ HIGH CAPACITY MAGAZINE

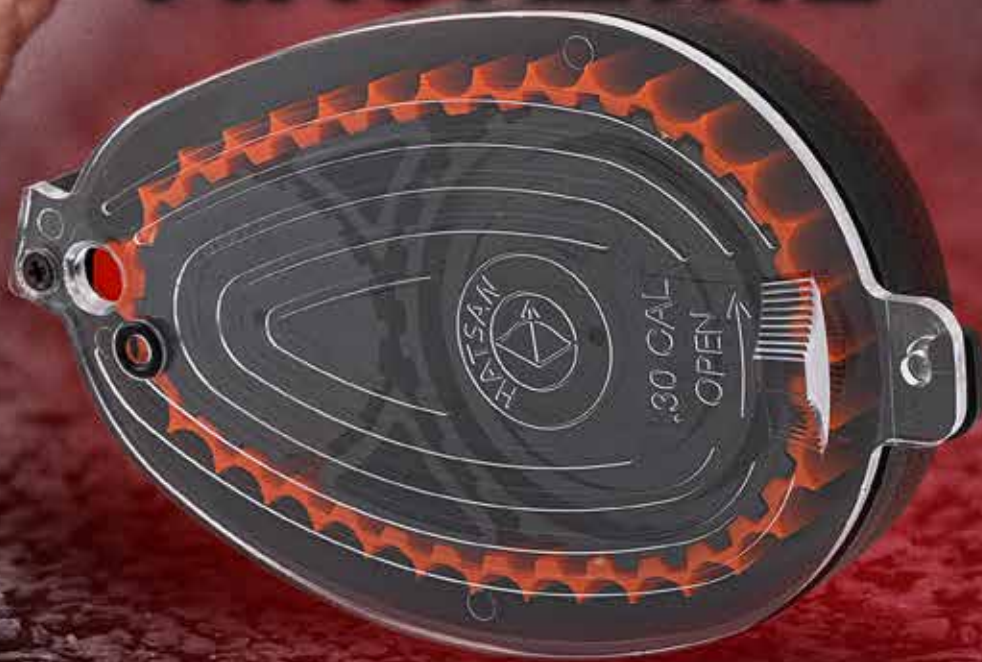

MAGAZINES AND PELLETS



10-SHOT MAGAZINE

- Easily mounts to all AT44 & BT65 10-shot PCP series air rifles.
- Light in weight and made of aluminum.
- Spare 10-shot magazines are available in .177 (4.5mm) and .22 (5.5mm) calibers.
- Spare 9-shot magazines are available in .25 (6.35mm) caliber



GALATIAN MAGAZINE

Spare magazines for Galatian PCP air rifles are available in 16 shot in .177 (4.5mm), 14 shot in .22 (5.5mm) and 13 shot in .25 (6.35mm) caliber.

BLITZ & FACTOR MAGAZINE



21-shot magazine in .22 (5.5mm), 19-shot magazine in .25 (6.35mm) and 16-shot magazine in .30 (7.62mm) caliber

SPEED MAG LOADER



Speed mag loader can be used with Blitz magazines.

HIGH CAPACITY MAGAZINE



High capacity magazine can be used in all Factor models.

HATSAN POINTED HEAD PELLETS

High performance, accurate and precise for pest control and precision shooting at larger distances. Pointed head & waisted design lead pellets providing maximum penetration on the target. Recommended to use on Hatsan products.

Hatsan pointed head pellets are available in .177 (4.5mm), .22 (5.5mm) and .25 (6.35mm) calibers.



- .177 (4.5mm) caliber Hatsan pointed head pellets. 200 pellets per tin.
- Weight: 0.545grams / 8.41grains.



- .22 (5.5mm) caliber Hatsan pointed head pellets. 300 pellets per tin.
- Weight: 0.910 grams / 14grains.



- .25 (6.35mm) caliber Hatsan pointed head pellets. 200 pellets per tin.
- Weight: 1,61grams / 24,85 grains.



Serious. Solid. Impact

PCP ACCESSORIES



SOUND MODERATOR

- Reduces the sound significantly.
- ½" UNF threaded and easily mountable on the muzzle.
- Made of aluminum alloy and light in weight.



EXTENDED MUZZLE BREAK

- Extended & ported muzzle break for a different look.
- ½" UNF threaded and easily mountable on the muzzle.



AIR STRIPPER

Air stripper helps to get better accuracy and grouping by decreasing the air turbulence at the muzzle as the pellet leaves the muzzle.



HATSAN PCP BAG

Special design bag fitting all Hatsan PCP air rifles. Made of quality and waterproof material and can carry your air rifle with scope mounted.



HATSAN HAND PUMP

- The most convenient and affordable way to charge your PCP air rifle.
- Maximum 200 bar fill pressure.
- Ergonomically designed handle with synthetic cover.
- Built-in moisture trap embedded in the handle which traps the moisture and protects your pump & air rifle.
- Built-in particle filter embedded in the handle which traps the dust & dirt and protects your pump & air rifle.
- Additional compartment in the other handle where you can put spare parts and O-rings of the pump or small belongings.
- Built-in precise pressure gauge embedded in the frame which protects it from external impacts.
- Easily demountable design.
- Specialist design wide foot plate with adjustable pumping angle.
- Comes with hose and connector.



AIR TUBE CYLINDER

- Detachable air cylinder
- Maximum fill pressure 200 bar.
- Easily screws in to the all Hatsan AT44 PCP series air rifles.
- Possibility of refilling the air tube while on the rifle or detached.



HATSAN CHARGING KIT

Designed to fill air into the air cylinder of your PCP from scuba tanks. The quickest method to fill your PCP.



HATSAN PLASTIC CASE

Designed for Hatsan PCP air rifles.



Foregrip with expandable bipod

UNIQUE FEATURES FROM HATSAN



Quattro Trigger

This advanced two-stage match trigger is only available from Hatsan. It offers three-point adjustment to control the trigger load, the position of the first and second stages of the firing cycle, and the length of trigger travel—all while maintaining full sear engagement. The custom trigger also allows you to release finger pressure if the shot cannot be taken after engaging in the first stage of the firing cycle, automatically returning the trigger to full engagement. And a drop safety interlock device has been incorporated to eliminate the possibility of the airgun accidentally firing if it's dropped (whether or not the safety is on).



The proprietary Shock Absorber System reduces vibration and increases the life of the gun, optics, and accessories.



TRUGLO Fiber Optics

Fiber-optic technology has been integrated into a microadjustable rear sight and front sight to lend more accuracy to your shot.



QuietEnergy Sound moderator in fully shrouded barrel for reduced down-range noise—Approximately 50% Quieter.

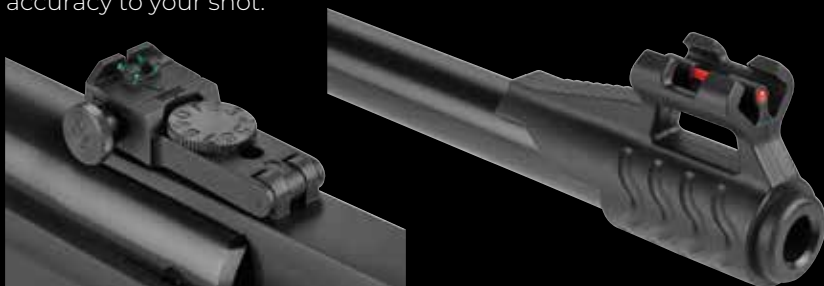

XRS - Recoil Reduction System

Hatsan air pistols are equipped with Hatsan's "XRS-Recoil Reduction System" for a noticeably smooth shot. Recoil is absorbed during the shot by the design of the sliding action. This makes for a more accurate and comfortable shooting experience.



TRIOPAD® Butt System

Maximum recoil absorption provides added comfort, and three stock spacers allow adjustments for appropriate length of pull.

VORTEX

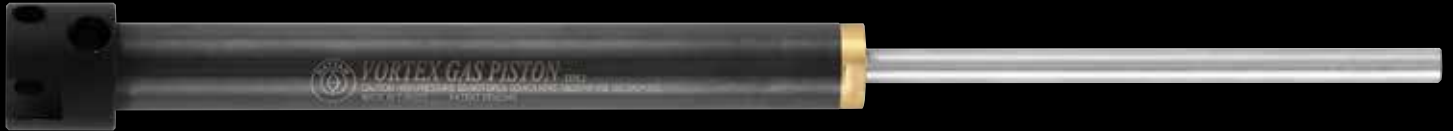

WHY HATSAN VORTEX GAS PISTONS?

Unlike our competitors, Hatsan Vortex Gas Pistons technology is developed and manufactured by Hatsan to be specifically used in most Hatsan Break Barrel and Under Lever airguns. Hatsan Vortex Gas Pistons utilize regular air instead of any other type of gas. Hatsan offers 6 different types of Hatsan Vortex Gas Pistons – encompassing the majority of Hatsan's line of Break Barrel and Underlever spring action guns. The following models are offered:

Type 1 : Mod 55-60-70-75-80-85-90

Type 1-B : Mod 88-95-99

Type 2 : Mod 125-125TH-125 Sniper-135 -Torpedo 150-150TH-155

Type 3 : Striker 1000S-1000X-Edge

Type 4 : Dominator under lever series

Type 5 : Torpedo 100X-105X under lever series

Type 6 : Mod 25 SuperCharger / SuperTact

Type 7 : Proxima

Benefits of Gas Piston Airguns

- Gas piston powered airguns can remain cocked for long periods of time without causing any spring stress or damage to the gun.
- Gas piston powered airguns produce more steady and consistent power between consecutive shots versus spring powered airguns.
- Gas Piston powered airguns eliminate most of the vibration caused by the oscillation of the heavy springs used in spring powered airguns. Gas Piston models oscillate much less and finish the action cycle in less time than spring powered models making for a more comfortable confident shooting experience.
- Gas piston powered airguns' lifecycle is significantly greater than its spring action counterparts. There is no risk of spring fatigue or spring breakage. Fewer moving parts result in a much more efficient and reliable operating system.
- Gas piston powered airguns provide higher, consistent velocities over their lifetime when compared to spring action models. Springs get weaker over time causing decreases in velocity.
- Gas piston powered airguns provide a much smoother and quieter shooting experience than their spring action counterparts. With gas powered models, the cocking action is much smoother. Also, spring grinding noises are eliminated during the cocking and firing sequence.



- More steady and consistent power between consecutive shots.
- Eliminates most vibration caused by oscillation of heavy springs.
- Much smoother and quieter shooting experience.



MOD 125



TRIOPAD® Butt System
The Hatsan TRIOPAD® Butt System utilizes a heavy duty rubber recoil pad and 3 stock spacers. This allows for maximum recoil absorption and up to 4 different length of pull options.

| Model | | MOD 125 | | | MOD 125TH | | |
|-------------------------------------|--------------------|---|--------------------|-------------------|---|--------------------|-------------------|
| Caliber | | 4.5 mm / .177 cal | 5.5 mm / .22 cal | 6.35 mm / .25 cal | 4.5 mm / .177 cal | 5.5 mm / .22 cal | 6.35 mm / .25 cal |
| Max. Muzzle Velocity (*) | | 380 m/s (1250 fps) | 305 m/s (1000 fps) | 230 m/s (750 fps) | 380 m/s (1250 fps) | 305 m/s (1000 fps) | 230 m/s (750 fps) |
| Stock | | Advanced Polymer with montecarlo cheekpiece & Triopad butt system | | | Advanced Polymer with thumbhole & montecarlo cheekpiece | | |
| Length | | 1240 mm (48.8") | | | 1205 mm (47.4") | | |
| Barrel Length | | 450mm (17.7") | | | 450mm (17.7") | | |
| Weight | | 3.8 kg (8.4 lbs) | | | 4.1 kg (9 lbs) | | |
| Fiber Optic Sights Diameters | Rear Sight | 0.9 mm (.035") green | | | 0.9 mm (.035") green | | |
| | Front Sight | 1.5 mm (.060") red | | | 1.5 mm (.060") red | | |

* Above maximum muzzle velocity figures may differ depending on the pellet weight & shape.

* The energy restrictions of a particular country can be achieved by the reduction in the muzzle velocity. The above maximum velocity figures are obtained when there is no energy restriction on the air rifle.

1250fpsPOWER!
with Lead Pellets



MOD 125 PRO



| Model | Caliber | Max. Muzzle Velocity (*) | Stock | Length | Barrel Length | Weight | Fiber Optic Sights Diameters | |
|-------------|-----------------|--------------------------|---------------------------------|----------------|---------------|-----------------|------------------------------|-------------------|
| | | | | | | | Rear Sight | Front Sight |
| MOD 125 PRO | 4.5mm / .177cal | 380 m/s (1250 fps) | Advanced Polymer with thumbhole | 1205mm (47.4") | 45cm (17.7") | 3,96kg (8,8lbs) | 0.9mm (.035") green | 1.5mm (.060") red |
| | 5.5mm / .22cal | 305 m/s (1000 fps) | | | | | | |
| | 6.35mm / .25cal | 230 m/s (750 fps) | | | | | | |



MOD 125 PRO CAMO



MOD 125 PRO MW



MOD 125 PRO QE

(*) Scope sold separately



Protector included with Mod 125 PRO QE only

| Model | Caliber | Max. Muzzle Velocity (*) | Stock | Length | Barrel Length | Weight |
|----------------|-----------------|--------------------------|---------------------------------|--------------|----------------|-----------------|
| MOD 125 PRO QE | 4.5mm / .177cal | 380 m/s (1250 fps) | Advanced Polymer with thumbhole | 1220mm (48") | 32,5cm (12,8") | 3,96kg (8,8lbs) |
| | 5.5mm / .22cal | 305 m/s (1000 fps) | | | | |
| | 6.35mm / .25cal | 230 m/s (750 fps) | | | | |

(*) Velocity results may vary as much as 20% due to pellet weight, pellet shape, temperature elevation as well as other factors. Above Maximum muzzle velocity figures may differ depending on the pellet weight & shape. The energy restrictions of a particular country can be achieved by the reduction in the muzzle velocity. The above maximum velocity figures are obtained when there is no energy restriction on the air rifle.



Serious. Solid. Impact

1250fps POWER!
with Lead Pellets

MOD 125 SNIPER

Elevation adjustable comb.



Metal trigger blade



Vortex Gas Piston Upgrade Available

Integrated Sound Moderator
Sound moderator in muzzlebreak for reduced down-range noise



**MOD 125
SNIPER CAMO**



Mossy Oak Break-Up camo version.



**MOD 125
SNIPER MW**

Luxurious walnut woodgrain camo version.

| Model | | MOD 125 Sniper | | |
|------------------------------|-------------|---|--------------------|-------------------|
| Caliber | | 4.5 mm / .177 cal | 5.5 mm / .22 cal | 6.35 mm / .25 cal |
| Max. Muzzle Velocity (*) | | 380 m/s (1250 fps) | 305 m/s (1000 fps) | 230 m/s (750 fps) |
| Stock | | Advanced Polymer with elevation adjustable comb | | |
| Length | | 1240 mm (48.8") | | |
| Barrel Length | | 360mm (14.2") | | |
| Weight | | 4.1 kg (9 lbs) | | |
| Fiber Optic Sights Diameters | Rear Sight | 0.9 mm (.035") green | | |
| | Front Sight | 1.5 mm (.060") red | | |

* Above maximum muzzle velocity figures may differ depending on the pellet weight & shape.
* The energy restrictions of a particular country can be achieved by the reduction in the muzzle velocity.
The above maximum velocity figures are obtained when there is no energy restriction on the air rifle.



TRIOPAD® Butt System

The Hatsan TRIOPAD® Butt System utilizes a heavy duty rubber recoil pad and 3 stock spacers. This allows for maximum recoil absorption and up to 4 different length of pull options.

1250fps POWER!
with Lead Pellets

QuietEnergy Series



Serious. Solid. Impact

MOD 135 QE SNIPER

**FULLY SHROUDED
BARREL**

Available in **30** cal.



QuietEnergy Version
QE fully shrouded barrel and
Integrated Sound Moderator -
Approximately 50% Quieter.

| Model | Mod135QE Sniper | | | |
|------------------------------|--|---------------------|-------------------|-------------------|
| Caliber | 4.5mm / .177cal | 5.5mm / .22cal | 6.35mm / .25cal | 7.62mm / .30cal |
| Max. Muzzle Velocity (*) | 380 m/s (1250 fps) | 305 m/s (1000 fps) | 230 m/s (750 fps) | 170 m/s (550 fps) |
| Stock | Advanced Polymer elevation adjustable comb | | | |
| Length | 1182mm (46.5") | | | |
| Barrel Length | 270mm (10.6") | | | |
| Weight | 4.15kg (9.15lbs) | | | |
| Fiber Optic Sights Diameters | Rear Sight | 0.9mm (.035") green | | |
| | Front Sight | 1.5mm (.060") red | | |



Includes 3 stock spacers to extend to stock length.

* Above maximum muzzle velocity figures may differ depending on the pellet weight & shape.
* The energy restrictions of a particular country can be achieved by the reduction in the muzzle velocity. The above maximum velocity figures are obtained when there is no energy restriction on the air rifle.



(* Scope sold separately)



MOD 135QE

Genuine walnut stock version.



Gold plated metal
trigger blade.



Elevation
adjustable
comb

| Model | Mod135QE | | |
|------------------------------|--|---------------------|-------------------|
| Caliber | 4.5mm/.177cal | 5.5mm/.22cal | 6.35mm/.25cal |
| Max. Muzzle Velocity (*) | 380 m/s (1250 fps) | 305 m/s (1000 fps) | 230 m/s (750 fps) |
| Stock | Genuine Turkish walnut elevation adjustable comb | | |
| Length | 1200mm (47.2") | | |
| Barrel Length | 270mm (10.6") | | |
| Weight | 4.35kg (9.6lbs) | | |
| Fiber Optic Sights Diameters | Rear Sight | 0.9mm (.035") green | |
| | Front Sight | 1.5mm (.060") red | |

* Above maximum muzzle velocity figures may differ depending on the pellet weight & shape.
* The energy restrictions of a particular country can be achieved by the reduction in the muzzle velocity. The above maximum velocity figures are obtained when there is no energy restriction on the air rifle.



Serious. Solid. Impact

QuietEnergy Series

1250fps POWER!
with Lead Pellets

MOD 130 QE

Available in **30** cal.

FULLY SHROUDED
BARREL



QuietEnergy Version
QE fully shrouded barrel and
Integrated Sound Moderator -
Approximately 50% Quieter.

| Model | | Mod130QE | | | |
|--------------------------|-------------|---|--------------------|-------------------|-------------------|
| Caliber | | 4.5mm / .177cal | 5.5mm / .22cal | 6.35mm / .25cal | 7.62mm / .30cal |
| Max. Muzzle Velocity (*) | | 380 m/s (1250 fps) | 305 m/s (1000 fps) | 230 m/s (750 fps) | 170 m/s (550 fps) |
| Stock | | Advanced Polymer, thumbhole elevation adjustable comb | | | |
| Length | | 1180mm (46.4") | | | |
| Barrel Length | | 270 mm (10.6") | | | |
| Weight | | 4.26kg (9.4lbs) | | | |
| Fiber Optic | Rear Sight | 0.9mm (.035") green | | | |
| Sights Diameters | Front Sight | 1.5mm (.060") red | | | |

* Above maximum muzzle velocity figures may differ depending on the pellet weight & shape.
* The energy restrictions of a particular country can be achieved by the reduction in the muzzle velocity. The above maximum velocity figures are obtained when there is no energy restriction on the air rifle.



MOD 130
Unshrouded barrel with front sight.
(No sound moderator)

| Model | | Mod130 | | | |
|--------------------------|-------------|---|--------------------|-------------------|-------------------|
| Caliber | | 4.5mm / .177cal | 5.5mm / .22cal | 6.35mm / .25cal | 7.62mm / .30cal |
| Max. Muzzle Velocity (*) | | 380 m/s (1250 fps) | 305 m/s (1000 fps) | 230 m/s (750 fps) | 170 m/s (550 fps) |
| Stock | | Advanced Polymer, thumbhole elevation adjustable comb | | | |
| Length | | 1238mm (48.7") | | | |
| Barrel Length | | 415mm (16.3") | | | |
| Weight | | 4.36kg (9.6lbs) | | | |
| Fiber Optic | Rear Sight | 0.9mm (.035") green | | | |
| Sights Diameters | Front Sight | 1.5mm (.060") red | | | |

* Above maximum muzzle velocity figures may differ depending on the pellet weight & shape.
* The energy restrictions of a particular country can be achieved by the reduction in the muzzle velocity. The above maximum velocity figures are obtained when there is no energy restriction on the air rifle.

1250fps POWER!
with Lead Pellets



Serious. Solid. Impact

MOD 135



| Model | MOD 135 | | |
|------------------------------|---|----------------------|-------------------|
| Caliber | 4.5 mm / .177 cal | 5.5 mm / .22 cal | 6.35 mm / .25 cal |
| Max. Muzzle Velocity (*) | 380 m/s (1250 fps) | 305 m/s (1000 fps) | 230 m/s (750 fps) |
| Stock | Turkish Walnut with montecarlo cheekpiece | | |
| Length | 1200 mm (47.2") | | |
| Barrel Length | 450 mm (17.7") | | |
| Weight | 4.2 kg (9.2 lbs) | | |
| Fiber Optic Sights Diameters | Rear Sight | 0.9 mm (.035") green | |
| | Front Sight | 1.5 mm (.060") red | |

* Above maximum muzzle velocity figures may differ depending on the pellet weight & shape.
* The energy restrictions of a particular country can be achieved by the reduction in the muzzle velocity. The above maximum velocity figures are obtained when there is no energy restriction on the air rifle.



TRIOPAD® Butt System

The Hatsan TRIOPAD® Butt System utilizes a heavy duty rubber recoil pad and 3 stock spacers. This allows for maximum recoil absorption and up to 4 different length of pull options.

- Combo scope mount rail good for both 11 mm and 22 mm mounts.
- 1 Shock absorber scope stop.
- Manual Safety.
- Automatic Safety.
- Anti Bear-Trap.





Serious. Solid. Impact

QuietEnergy Series

45 Joule Power!

CARNIVORE 135

7.62mm caliber (.30cal) big bore

FULLY SHROUDED BARREL



Available in **30** cal.



QuietEnergy Version
QE fully shrouded barrel and Integrated Sound Moderator - Approximately 50% Quieter.

7.62mm caliber (.30cal) big bore. Single shot break barrel action. QuietEnergy fully shrouded barrel and Integrated Sound Moderator - **Approximately 50% Quieter.** Quattro Trigger is a 2-Stage fully adjustable match trigger system. SAS Shock Absorber System significantly reduces vibration. High quality and genuine Turkish walnut stock-hunting style, ergonomic and stylish design and montecarlo cheekpiece. Elevation adjustable comb. Checkering on grip and forearm for better control and feel. Scope mount rail for both 11mm & 22mm mounts. Shock absorber scope stop. Gold plated trigger blade. Precision rifled steel barrel. Manual safety & automatic cocking safety. Anti bear-trap safety. Micro adjustable rear sight for both windage and elevation with Truglo fiber optics. Open metal front sight with Truglo fiber optics.



(*) Scope sold separately



Elevation adjustable comb

| | | |
|-------------------------------------|--|---------------------|
| Model | Carnivore 135 | |
| Caliber | 7.62mm / .30cal | |
| Max. Muzzle Velocity (*) | 170 m/s (550 fps) | |
| Stock | Genuine Turkish walnut elevation adjustable comb | |
| Length | 1200mm (47.2") | |
| Barrel Length | 270mm (10.6") | |
| Weight | 4.35kg (9.6lbs) | |
| Fiber Optic Sights Diameters | Rear Sight | 0.9mm (.035") green |
| | Front Sight | 1.5mm (.060") red |

* Above maximum muzzle velocity figures may differ depending on the pellet weight & shape.
* The energy restrictions of a particular country can be achieved by the reduction in the muzzle velocity.
The above maximum velocity figures are obtained when there is no energy restriction on the air rifle.

1250fps POWER!
with Lead Pellets



Serious. Solid. Impact

SPEEDFIRE 1250



Integrated Sound Moderator
Sound moderator in muzzlebreak for reduced down-range noise



Break barrel 12 shot repeater in .177 (4.5mm) and 10 shot repeater in .22 (5.5mm) caliber. Includes 2 detachable Rapid Performance Mag (RPM) magazines. With a single motion, Hatsan's "EZ-Load Action System" quickly cocks and loads the gun. Vortex gas piston power source. Integrated Sound Moderator in muzzle break for reduced down-range noise. Quattro Trigger is a 2-Stage fully adjustable match trigger system. SAS- Shock Absorber System significantly reduces vibration. Manual safety & automatic cocking safety. Anti bear-trap cocking arm safety. Metal trigger blade.



Includes 2 detachable Rapid Performance Mag (RPM) magazines.
12-shot RPM magazine in .177 (4.5mm) and 10 shot RPM magazine in .22 (5.5mm) caliber



Rapid Performance Mag (RPM) magazines are easily detachable with a touch of button. With a single motion, Hatsan's EZ-Load Action System quickly cocks and loads the gun. Micro adjustable rear sight for both windage and elevation with Truglo fiber optics.



(* Scope sold separately)

| Model | SpeedFire1250 | |
|--------------------------------------|----------------------|----------------------|
| Caliber | 4.5mm / .177cal | 5.5mm / .22cal |
| Max. Muzzle Velocity-Lead Pellet (*) | 380m/s (1250fps) | 305m/s (1000fps) |
| Energy | 24 Joule (18 ft/lbs) | 27 Joule (20 ft/lbs) |
| Magazine Capacity | 12 | 10 |
| Stock | Advanced Polymer | |
| Length | 1243mm (48.9") | |
| Barrel Length | 360mm (14") | |
| Weight | 3.6kg (7.9lbs) | |
| Fiber Optic Sights Diameters | Rear Sight | 0.9mm (.035") green |
| | Front Sight | 1.5mm (.060") red |

* Above maximum muzzle velocity figures may differ depending on the pellet weight & shape.
* The energy restrictions of a particular country can be achieved by the reduction in the muzzle velocity. The above maximum velocity figures are obtained when there is no energy restriction on the air rifle.



Foldable front sight with Truglo fiber optics



Serious. Solid. Impact

1000fps POWER!
with Lead Pellets

SPEEDFIRE

**FULLY SHROUDED
BARREL**



Integrated Sound Moderator
Sound moderator in muzzlebreak for reduced down-range noise



SPEEDFIRE W

Break barrel 12 shot repeater in .177 (4.5mm) and 10 shot repeater in .22 (5.5mm) caliber. Includes 2 detachable Rapid Performance Mag (RPM) magazines. With a single motion, Hatsan's "EZ-Load Action System" quickly cocks and loads the gun. Vortex gas piston power source. Integrated Sound Moderator in muzzle break for reduced down-range noise. Precision rifled steel barrel with synthetic shroud. Quattro Trigger is a 2-Stage fully adjustable match trigger system. SAS- Shock Absorber System significantly reduces vibration. Manual safety & automatic cocking safety. Anti bear-trap cocking arm safety. Stylish design ambidextrous synthetic stock. Metal trigger blade.



Includes 2 detachable Rapid Performance Mag (RPM) magazines.
12-shot RPM magazine in .177 (4.5mm) and 10 shot RPM magazine in .22 (5.5mm) caliber



(*) Scope sold separately

Rapid Performance Mag (RPM) magazines are easily detachable with a touch of button. With a single motion, Hatsan's EZ-Load Action System quickly cocks and loads the gun. Micro adjustable rear sight for both windage and elevation with Truglo fiber optics.

| Model | SpeedFire | | SpeedFire W | |
|--------------------------------------|----------------------|----------------------|----------------------|----------------------|
| Caliber | 4.5mm / .177cal | 5.5mm / .22cal | 4.5mm / .177cal | 5.5mm / .22cal |
| Max. Muzzle Velocity-Lead Pellet (*) | 305 m/s (1000 fps) | 245 m/s (800 fps) | 305 m/s (1000 fps) | 245 m/s (800 fps) |
| Energy | 24 Joule (18 ft/lbs) | 27 Joule (20 ft/lbs) | 24 Joule (18 ft/lbs) | 27 Joule (20 ft/lbs) |
| Magazine Capacity | 12 | 10 | 12 | 10 |
| Stock | Advanced Polymer | | Walnut | |
| Length | 1190mm (46.85") | | 1195mm (47") | |
| Barrel Length | 370mm (14.5") | | 370mm (14.5") | |
| Weight | 3kg (6.6lbs) | | 3.4kg (7.5lbs) | |
| Fiber Optic Sights | Rear Sight | 0.9mm (.035") green | 0.9mm (.035") green | |
| | Front Sight | 1.5mm (.060") red | 1.5mm (.060") red | |

* Above maximum muzzle velocity figures may differ depending on the pellet weight & shape.

* The energy restrictions of a particular country can be achieved by the reduction in the muzzle velocity. The above maximum velocity figures are obtained when there is no energy restriction on the air rifle.

820fps POWER!
with Lead Pellets



Serious. Solid. Impact

PROXIMA

UNDERLEVER



WORLD'S FIRST
14 SHOT
Underlever repeater available in 3 calibers!



14 shot repeater in .177 (4.5mm) , 12 shot repeater in .22 (5.5mm) and 10 shot repeater in .25 (6.35mm) calibers. Vortex gas piston power source. Black chrome finish barrel and cylinder provides maximum corrosion resistance. Fixed barrel / under lever cocking system. Quattro Trigger is a 2-Stage fully adjustable match trigger system. SAS- Shock Absorber System significantly reduces vibration. Anti bear-trap cocking arm safety. Stylish design genuine Turkish walnut ambidextrous stock. Scope mount rail & shock absorber scope stop. Gold plated trigger blade. Includes 3 stock spacers to extend to stock length.



(*) Scope sold separately

Elevation adjustable comb.



Three stock length of pull spacers are included. The stock length of pull can be extended by increments of 5mm (1/5") by simply inserting one or more of these spacers. With these spacers any shooter can perfectly fit the suitable stock length of pull.



| Model | Proxima | | |
|--------------------------|--|---------------------|-----------------|
| Caliber | 4.5mm / .177cal | 5.5mm / .22cal | 6.35mm / .25cal |
| Max. Muzzle Velocity (*) | 250m/s (820fps) | 220m/s (720fps) | 190m/s (620fps) |
| Magazine Capacity | 14 | 12 | 10 |
| Stock | Genuine Turkish walnut. Ambidextrous and ergonomic design with thumbhole. Elevation adjustable comb. | | |
| Overall Length | 1153mm (45.4") | | |
| Barrel Length | 420mm (15.5") | | |
| Weight | 4.25kg (9.3lbs) | | |
| Fiber Optic | Rear Sight | 0.9mm (.035") green | |
| Sights Diameters | Front Sight | 1.5mm (.060") red | |

* Above maximum muzzle velocity figures may differ depending on the pellet weight & shape.
* The energy restrictions of a particular country can be achieved by the reduction in the muzzle velocity.
The above maximum velocity figures are obtained when there is no energy restriction on the air rifle.

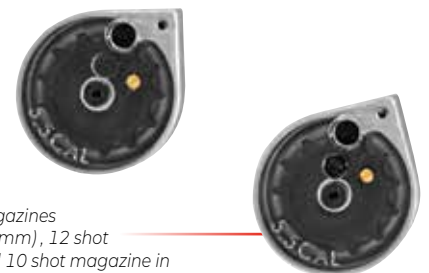

Includes 2 detachable clip magazines
14 shot magazine in .177 (4.5 mm) , 12 shot magazine in .22 (5.5 mm) and 10 shot magazine in .25 (6.35 mm) caliber.

DOMINATOR 200W

UNDERLEVER



Elevation adjustable comb.



Elevation adjustable comb.



Dominator 200W Carbine is equipped with 1/2" UNF threaded muzzle for sound moderator & with muzzle cap.

Three stock length of pull spacers are included. The stock length of pull can be extended by increments of 5mm (1/5") by simply inserting one or more of these spacers. With these spacers any shooter can perfectly fit the suitable stock length of pull.



| Model | Dominator 200W Carbine | | |
|--------------------------|---|------------------|-------------------|
| Caliber | 4.5 mm / .177 cal | 5.5 mm / .22 cal | 6.35 mm / .25 cal |
| Max. Muzzle Velocity (*) | 305 m/s (1000 fps) | 245 m/s (800fps) | 200 m/s (650 fps) |
| Stock | Turkish Walnut with adjustable comb and adjustable butt | | |
| Length | 1098mm (43.2") | | |
| Barrel Length | 400mm (15.7") | | |
| Weight | 4.4kg (9.7 lbs) | | |

| Model | Dominator 200W | | |
|------------------------------|---|---------------------|-------------------|
| Caliber | 4.5 mm / .177 cal | 5.5 mm / .22 cal | 6.35 mm / .25 cal |
| Max. Muzzle Velocity (*) | 305 m/s (1000 fps) | 245 m/s (800fps) | 200 m/s (650 fps) |
| Stock | Turkish Walnut with adjustable comb and adjustable butt | | |
| Length | 1156mm (45.5") | | |
| Barrel Length | 450mm (17.7") | | |
| Weight | 4.5kg (9.9 lbs) | | |
| Fiber Optic Sights Diameters | Rear Sight | 0.9mm (.035") green | |
| | Front Sight | 1.5mm (.060") red | |

* Above maximum muzzle velocity figures may differ depending on the pellet weight & shape.

* The energy restrictions of a particular country can be achieved by the reduction in the muzzle velocity. The above maximum velocity figures are obtained when there is no energy restriction on the air rifle.

1250fps POWER!
with Lead Pellets



TORPEDO 150 UNDERLEVER



Metal trigger blade



Vortex Gas Piston Upgrade Available



TORPEDO 150 OD

OD green stock version.



TORPEDO 150 CAMO

Mossy Oak Break-Up camo version.



TORPEDO 150 MW

Luxurious walnut woodgrain camo version.



TORPEDO 150TH



Metal trigger blade



Vortex Gas Piston Upgrade Available



TORPEDO 150TH OD

OD green stock version.



TORPEDO 150TH CAMO

Mossy Oak Break-Up camo version.



TORPEDO 150TH MW

Luxurious walnut woodgrain camo version.



TRIOPAD® Butt System

The Hatsan TRIOPAD® Butt System utilizes a heavy duty rubber recoil pad and 3 stock spacers. This allows for maximum recoil absorption and up to 4 different length of pull options.

| Model | Torpedo 150 | | | Torpedo 150TH | | |
|------------------------------|---|----------------------|-------------------|---|--------------------|-------------------|
| Caliber | 4.5 mm / .177 cal | 5.5 mm / .22 cal | 6.35 mm / .25 cal | 4.5 mm / .177 cal | 5.5 mm / .22 cal | 6.35 mm / .25 cal |
| Max. Muzzle Velocity (*) | 380 m/s (1250 fps) | 305 m/s (1000 fps) | 230 m/s (750 fps) | 380 m/s (1250 fps) | 305 m/s (1000 fps) | 230 m/s (750 fps) |
| Stock | Advanced Polymer with montecarlo cheekpiece | | | Advanced Polymer with thumbhole & montecarlo cheekpiece | | |
| Length | 1210 mm (47.6") | | | 1170 mm (46") | | |
| Barrel Length | 430 mm (17") | | | 430 mm (17") | | |
| Weight | 4.3 kg (9.4lbs) | | | 4.6 kg (10 lbs) | | |
| Fiber Optic Sights Diameters | Rear Sight | 0.9 mm (.035") green | | 0.9 mm (.035") green | | |
| | Front Sight | 1.5 mm (.060") red | | 1.5 mm (.060") red | | |

* Above maximum muzzle velocity figures may differ depending on the pellet weight & shape.

* The energy restrictions of a particular country can be achieved by the reduction in the muzzle velocity. The above maximum velocity figures are obtained when there is no energy restriction on the air rifle.

TORPEDO 155

UNDERLEVER



Gold plated metal trigger blade.

Vortex Gas Piston Upgrade Available



Fixed barrel & under lever cocking system.



Micro adjustable rear sight.

- Combo scope mount rail good for both 11 mm and 22 mm mounts.
- 1 Shock absorber scope stop.
- Manual Safety.
- Automatic Safety.
- Anti Bear-Trap.



Bolt action loading system providing maximum power.

| Model | Torpedo 155 | | |
|--------------------------|---|----------------------|-------------------|
| Caliber | 4.5 mm / .177 cal | 5.5 mm / .22 cal | 6.35 mm / .25 cal |
| Max. Muzzle Velocity (*) | 380 m/s (1250 fps) | 305 m/s (1000 fps) | 230 m/s (750 fps) |
| Stock | Turkish Walnut with montecarlo cheekpiece | | |
| Length | 1210 mm (47.6") | | |
| Barrel Length | 430 mm (17") | | |
| Weight | 4.8 kg (11 lbs) | | |
| Fiber Optic | Rear Sight | 0.9 mm (.035") green | |
| Sights Diameters | Front Sight | 1.5 mm (.060") red | |

* Above maximum muzzle velocity figures may differ depending on the pellet weight & shape.
* The energy restrictions of a particular country can be achieved by the reduction in the muzzle velocity. The above maximum velocity figures are obtained when there is no energy restriction on the air rifle.



TRIOPAD® Butt System

The Hatsan TRIOPAD® Butt System utilizes a heavy duty rubber recoil pad and 3 stock spacers. This allows for maximum recoil absorption and up to 4 different length of pull options.

1250fps POWER!
with Lead Pellets

QuietEnergy Series



TORPEDO 150 SNIPER UNDERLEVER



Integrated Sound Moderator
Sound moderator in muzzlebreak for reduced down-range noise



QUATTRO TRIGGER
Metal trigger blade



Elevation adjustable comb.

| Model | Torpedo 150 Sniper | | |
|------------------------------|--|---------------------|-------------------|
| Caliber | 4.5mm / .177cal | 5.5mm / .22cal | 6.35mm / .25cal |
| Max. Muzzle Velocity (*) | 380 m/s (1250 fps) | 305 m/s (1000 fps) | 230 m/s (750 fps) |
| Stock | Advanced Polymer thumbhole ambidextrous stock with adjustable comb and adjustable butt | | |
| Length | 1230 (48.4") | | |
| Barrel Length | 330 mm (13") | | |
| Weight | 4.2 kg (9.2 lbs) | | |
| Fiber Optic Sights Diameters | Rear Sight | 0.9mm (.035") green | |
| | Front Sight | 1.5mm (.060") red | |

* Above maximum muzzle velocity figures may differ depending on the pellet weight & shape.
* The energy restrictions of a particular country can be achieved by the reduction in the muzzle velocity. The above maximum velocity figures are obtained when there is no energy restriction on the air rifle.



TORPEDO 100X

UNDERLEVER



TORPEDO 105X



TORPEDO 105X CAMO



Mossy Oak Break-Up camo version.



TORPEDO 105X MW

Luxurious walnut woodgrain camo version.

| Model | Torpedo 100X | | | Torpedo 105X | | |
|--------------------------|---|----------------------|-------------------|---|-------------------|-------------------|
| Caliber | 4.5 mm / .177 cal | 5.5 mm / .22 cal | 6.35 mm / .25 cal | 4.5 mm / .177 cal | 5.5 mm / .22 cal | 6.35 mm / .25 cal |
| Max. Muzzle Velocity (*) | 305 m/s (1000 fps) | 245 m/s (800 fps) | 200 m/s (650 fps) | 305 m/s (1000 fps) | 245 m/s (800 fps) | 200 m/s (650 fps) |
| Stock | Turkish Walnut with montecarlo cheekpiece | | | Advanced Polymer with montecarlo cheekpiece | | |
| Length | 1200 mm (47.2") | | | 1200 mm (47.2") | | |
| Barrel Length | 430 mm (17") | | | 430 mm (17") | | |
| Weight | 4.2 kg (9.2 lbs) | | | 3.9 kg (8.6 lbs) | | |
| Fiber Optic | Rear Sight | 0.9 mm (.035") green | | 0.9 mm (.035") green | | |
| Sights Diameters | Front Sight | 1.5 mm (.060") red | | 1.5 mm (.060") red | | |

* Above maximum muzzle velocity figures may differ depending on the pellet weight & shape.

* The energy restrictions of a particular country can be achieved by the reduction in the muzzle velocity. The above maximum velocity figures are obtained when there is no energy restriction on the air rifle.

1000fps POWER!
with Lead Pellets

QuietEnergy Series



Serious. Solid. Impact

MOD 87QE



Fully shrouded barrel.



QuietEnergy Version
QE fully shrouded barrel and Integrated Sound Moderator - Approximately 50% Quieter.

Metal trigger blade

| Model | Mod87QE | | | Mod87W-QE | | |
|------------------------------|--|---------------------|-------------------|--|---------------------|-------------------|
| Caliber | 4.5mm / .177cal | 5.5mm / .22cal | 6.35mm / .25cal | 4.5mm / .177cal | 5.5mm / .22cal | 6.35mm / .25cal |
| Max. Muzzle Velocity (*) | 305 m/s (1000 fps) | 245 m/s (800 fps) | 200 m/s (650 fps) | 305 m/s (1000 fps) | 245 m/s (800 fps) | 200 m/s (650 fps) |
| Stock | Advanced Polymer elevation adjustable comb | | | Genuine Turkish walnut elevation adjustable comb | | |
| Length | 1132mm (44.5") | | | 1142mm (45") | | |
| Barrel Length | 270mm (10.6") | | | 270mm (10.6") | | |
| Weight | 3.35kg (7.4lbs) | | | 4.07kg (8.9lbs) | | |
| Fiber Optic Sights Diameters | Rear Sight | 0.9mm (.035") green | | | 0.9mm (.035") green | |
| | Front Sight | 1.5mm (.060") red | | | 1.5mm (.060") red | |

* Above maximum muzzle velocity figures may differ depending on the pellet weight & shape.

* The energy restrictions of a particular country can be achieved by the reduction in the muzzle velocity. The above maximum velocity figures are obtained when there is no energy restriction on the air rifle.

FULLY SHROUDED BARREL



MOD 87W QE

Gold plated metal trigger blade.



QuietEnergy Version
QE fully shrouded barrel and Integrated Sound Moderator - Approximately 50% Quieter.



MOD 87

Unshrouded barrel with hooded front sight. (No sound moderator)

Metal front sight with Truglo fiber optics.



MOD 87 CAMO

A-Tacs Tactical camo version

| Model | Mod87 | | |
|------------------------------|--|---------------------|-------------------|
| Caliber | 4.5mm / .177cal | 5.5mm / .22cal | 6.35mm / .25cal |
| Max. Muzzle Velocity (*) | 305 m/s (1000 fps) | 245 m/s (800 fps) | 200 m/s (650 fps) |
| Stock | Stock Advanced Polymer elevation adjustable comb | | |
| Length | 1150 mm (45.3") | | |
| Barrel Length | 450 mm (17.7") | | |
| Weight | 3.7kg (8,1lbs) | | |
| Fiber Optic Sights Diameters | Rear Sight | 0.9mm (.035") green | |
| | Front Sight | 1.5mm (.060") red | |



"EasyAdjust" Elevation Comb - Stock equipped with integrated elevation adjustment wheel - eliminating need for wrenches.

* Above maximum muzzle velocity figures may differ depending on the pellet weight & shape.

* The energy restrictions of a particular country can be achieved by the reduction in the muzzle velocity. The above maximum velocity figures are obtained when there is no energy restriction on the air rifle.



Serious. Solid. Impact

1000fps POWER!
with Lead Pellets

MOD 65

**FULLY SHROUDED
BARREL**



Integrated Sound Moderator
Sound moderator in muzzlebreak for reduced down-range noise



| Model | | MOD 65 | | |
|--------------------------------------|-------------|---------------------|------------------|------------------|
| Caliber | | 4.5mm / .177 cal | 5.5mm / .22 cal | 6.35mm / .25 cal |
| Max. Muzzle Velocity-Lead Pellet (*) | | 305m/s (1000 fps) | 245m/s (800 fps) | 200m/s (650 fps) |
| Stock | | Turkish Walnut | | |
| Length | | 1185mm (46.6") | | |
| Barrel Length | | 370mm (14.5") | | |
| Weight | | 3kg (6.6lbs) | | |
| Fiber Optic Sights | Rear Sight | 0.9mm (.035") green | | |
| Diameters | Front Sight | 1.5mm (.060") red | | |

**Above maximum muzzle velocity figures may differ depending on the pellet weight & shape.
The energy restrictions of a particular country can be achieved by the reduction in the muzzle velocity. The above maximum velocity figures are obtained when there is no energy restriction on the air rifle.



Fully shrouded barrel and Integrated Sound moderator in muzzle break for reduced downrange noise.
TRUGLO fiber optic sights with contrasting fiber colors.



- Ergonomic design walnut stock with elevation adjustable comb.
- Ventilated rubber butt pad for recoil absorption.
- Checkering on grip & forend for better control and feel.
- Quattro trigger
- Metal trigger blade

1000fpsPOWER!
with Lead Pellets

QuietEnergySeries



Serious. Solid. Impact

MOD 95



Vortex Gas Piston Upgrade Available

**FULLY SHROUDED
BARREL**

QuietEnergySeries



Vortex Gas Piston Upgrade Available

MOD 95 QE



QuietEnergy Version
QE fully shrouded barrel and
Integrated Sound Moderator -
Approximately 50% Quieter.



Gold plated metal
trigger blade.

- Combo scope mount rail good for both 11 mm and 22 mm mounts.
- 1 Shock absorber scope stop.
- Manual Safety.
- Automatic Safety.
- Anti Bear-Trap.

| Model | MOD 95 | | | Mod95 QE | | |
|---------------------------------|--------------------|----------------------|-------------------|------------------------|-------------------|-------------------|
| Caliber | 4.5 mm / .177 cal | 5.5 mm / .22 cal | 6.35 mm / .25 cal | 4.5mm / .177cal | 5.5mm / .22cal | 6.35mm / .25cal |
| Max. Muzzle Velocity (*) | 305 m/s (1000 fps) | 245 m/s (800 fps) | 200 m/s (650 fps) | 305 m/s (1000 fps) | 245 m/s (800 fps) | 200 m/s (650 fps) |
| Stock | Turkish Walnut | | | Genuine Turkish walnut | | |
| Length | 1125 mm (44.3") | | | 1132mm (44.5") | | |
| Barrel Length | 405mm (15.9") | | | 270mm (10.6") | | |
| Weight | 3.8 kg (8.4 lbs) | | | 3.45kg (7.6lbs) | | |
| Fiber Optic Sights Diameters | Rear Sight | 0.9 mm (.035") green | | 0.9mm (.035") green | | |
| | Front Sight | 1.5 mm (.060") red | | 1.5mm (.060") red | | |

*Above maximum muzzle velocity figures may differ depending on the pellet weight & shape.

*The energy restrictions of a particular country can be achieved by the reduction in the muzzle velocity. The above maximum velocity figures are obtained when there is no energy restriction on the air rifle.



Serious. Solid. Impact

1000fps POWER!
with Lead Pellets

MOD 85



Metal trigger blade



MOD 85 CAMO
Mossy Oak Break-Up camo version.



MOD 85 MW
Luxurious walnut woodgrain camo version.



TRIOPAD® Butt System

The Hatsan TRIOPAD® Butt System utilizes a heavy duty rubber recoil pad and 3 stock spacers. This allows for maximum recoil absorption and up to 4 different length of pull options.

Grooved cylinder for 11mm mounts mounted scope stop.



Manual Safety.
Automatic Safety.
Anti Bear-Trap.

| Model | MOD 85 | | |
|--------------------------|---|----------------------|-------------------|
| Caliber | 4.5 mm / .177 cal | 5.5 mm / .22 cal | 6.35 mm / .25 cal |
| Max. Muzzle Velocity (*) | 305 m/s (1000 fps) | 245 m/s (800 fps) | 200 m/s (650 fps) |
| Stock | Advanced Polymer with montecarlo cheekpiece & Triopad butt system | | |
| Length | 1125 mm (44") | | |
| Barrel Length | 450 mm (17.7") | | |
| Weight | 3.3 kg (7.2 lbs) | | |
| Fiber Optic | Rear Sight | 0.9 mm (.035") green | |
| Sights Diameters | Front Sight | 1.5 mm (.060") red | |

*Above maximum muzzle velocity figures may differ depending on the pellet weight & shape.

*The energy restrictions of a particular country can be achieved by the reduction in the muzzle velocity. The above maximum velocity figures are obtained when there is no energy restriction on the air rifle.

1000fpsPOWER!
with Lead Pellets



Serious. Solid. Impact

MOD 85X



(* Scope included with Mod 85X.



Vortex Gas Piston Upgrade Available



**MOD 85X
CAMO**



Mossy Oak Break-Up camo version.



MOD 85X MW

Luxurious walnut woodgrain camo version.



(* Scope included with Mod 85 SNIPER.

**MOD 85
SNIPER**



Vortex Gas Piston Upgrade Available

Integrated Sound Moderator
Sound moderator in muzzlebreak for reduced down-range noise



**MOD 85
SNIPER CAMO**



Mossy Oak Break-Up finish version.



**MOD 85
SNIPER MW**

Luxurious walnut woodgrain camo version.

| Model | MOD 85X | | |
|--------------------------|---|-------------------|-------------------|
| Caliber | 4.5 mm / .177 cal | 5.5 mm / .22 cal | 6.35 mm / .25 cal |
| Max. Muzzle Velocity (*) | 305 m/s (1000 fps) | 245 m/s (800 fps) | 200 m/s (650 fps) |
| Stock | Advanced Polymer with montecarlo cheekpiece & Triopad butt system | | |
| Length | 1125 mm (44") | | |
| Barrel Length | 275mm (10.8") | | |
| Weight | 3.3 kg (7.2 lbs) | | |
| Sight | Optima 3-9x32 Scope | | |

| Model | MOD 85 Sniper | | |
|--------------------------|---|----------------------|-------------------|
| Caliber | 4.5 mm / .177 cal | 5.5 mm / .22 cal | 6.35 mm / .25 cal |
| Max. Muzzle Velocity (*) | 305 m/s (1000 fps) | 245 m/s (800fps) | 200 m/s (650 fps) |
| Stock | Advanced Polymer with montecarlo cheekpiece | | |
| Length | 1135 mm (44.7") | | |
| Barrel Length | 320mm (12.6") | | |
| Weight | 3.3 kg (7.2 lbs) | | |
| Fiber Optic | Rear Sight | 0.9 mm (.035") green | |
| Sights Diameters | Front Sight | 1.5 mm (.060") red | |

*Above maximum muzzle velocity figures may differ depending on the pellet weight & shape.

*The energy restrictions of a particular country can be achieved by the reduction in the muzzle velocity. The above maximum velocity figures are obtained when there is no energy restriction on the air rifle.

MOD 70 & 55S



MOD 70

QUATTRO
TRIGGER
Metal trigger blade

SaS
Check Absorber System

VORTEX
GAS PISTON
Vortex Gas Piston Upgrade Available



MOD 70 CAMO
Mossy Oak Break-Up camo version.



MOD 70 MW
Luxurious walnut woodgrain camo version.

| Model | | MOD 70 | | |
|------------------------------|-------------|---|-------------------|-------------------|
| Caliber | | 4.5 mm / .177 cal | 5.5 mm / .22 cal | 6.35 mm / .25 cal |
| Max. Muzzle Velocity (*) | | 305 m/s (1000 fps) | 245 m/s (800 fps) | 200 m/s (650 fps) |
| Stock | | Advanced Polymer with montecarlo cheekpiece | | |
| Length | | 1135 mm (44.6") | | |
| Barrel Length | | 450 mm (17.7") | | |
| Weight | | 3.2 kg (7 lbs) | | |
| Fiber Optic Sights Diameters | Rear Sight | 0.9 mm (.035") green | | |
| | Front Sight | 1.5 mm (.060") red | | |

*Above maximum muzzle velocity figures may differ depending on the pellet weight & shape.
*The energy restrictions of a particular country can be achieved by the reduction in the muzzle velocity. The above maximum velocity figures are obtained when there is no energy restriction on the air rifle.



MOD 55S

QUATTRO
TRIGGER

SaS
Check Absorber System

VORTEX
GAS PISTON
Vortex Gas Piston Upgrade Available

| Model | | MOD 55S | | |
|------------------------------|-------------|---------------------|------------------|------------------|
| Caliber | | 4.5mm / .177 cal | 5.5mm / .22 cal | 6.35mm / .25 cal |
| Max. Muzzle Velocity (*) | | 305m/s (1000 fps) | 245m/s (800 fps) | 200m/s (650 fps) |
| Stock | | Wooden | | |
| Length | | 1140mm (45") | | |
| Barrel Length | | 450mm (17.7") | | |
| Weight | | 3.4kg (7.5 lbs) | | |
| Fiber Optic Sights Diameters | Rear Sight | 0.9mm (.035") green | | |
| | Front Sight | 1.5mm (.060") red | | |

*Above maximum muzzle velocity figures may differ depending on the pellet weight & shape.
*The energy restrictions of a particular country can be achieved by the reduction in the muzzle velocity. The above maximum velocity figures are obtained when there is no energy restriction on the air rifle.

1000fpsPOWER!
with Lead Pellets



MOD 80 & 90



MOD 80

QUATTRO
TRIGGER
Metal trigger blade

SaS
Shock Absorber System

VORTEX
GAS PISTON
Vortex Gas Piston Upgrade Available



MOD 80 CAMO
Mossy Oak Break-Up camo version.



MOD 80 MW
Luxurious walnut woodgrain camo version.



MOD 90

QUATTRO
TRIGGER
Metal trigger blade

SaS
Shock Absorber System

VORTEX
GAS PISTON
Vortex Gas Piston Upgrade Available



MOD 90 CAMO
Mossy Oak Break-Up camo version.



MOD 90 MW
Luxurious walnut woodgrain camo version.

| Model | | MOD 80 / 90 | | |
|---------------------------------|-------------|---|-------------------|-------------------|
| Caliber | | 4.5 mm / .177 cal | 5.5 mm / .22 cal | 6.35 mm / .25 cal |
| Max. Muzzle Velocity (*) | | 305 m/s (1000 fps) | 245 m/s (800 fps) | 200 m/s (650 fps) |
| Stock | | Advanced Polymer with montecarlo cheekpiece | | |
| Length | | 1135 mm (44.6") | | |
| Barrel Length | | 450 mm (17.7") | | |
| Weight | | 3.2 kg (7 lbs) | | |
| Fiber Optic Sights Diameters | Rear Sight | 0.9 mm (.035") green | | |
| | Front Sight | 1.5 mm (.060") red | | |

*Above maximum muzzle velocity figures may differ depending on the pellet weight & shape.
*The energy restrictions of a particular country can be achieved by the reduction in the muzzle velocity. The above maximum velocity figures are obtained when there is no energy restriction on the air rifle.



Serious. Solid. Impact

1000fpsPOWER!
with Lead Pellets

ZADA

**FULLY SHROUDED
BARREL**



Integrated Sound Moderator
Sound moderator in muzzlebreak for reduced down-range noise



ZADA



**ZADA
MOONSHINE**



**ZADA
CAMO**

| Model | Caliber | Max. Muzzle Velocity (*) | Stock | Length | Barrel Length | Weight | Fiber Optic Sights Diameters | |
|-------|-----------------|--------------------------|---------------------------------|----------------|---------------|---------------|------------------------------|-------------------|
| | | | | | | | Rear Sight | Front Sight |
| ZADA | 4.5mm / .177cal | 305 m/s (1000 fps) | Advanced Polymer Tactical Style | 1140mm (44,9") | 37cm (14,6") | 2,57 (5,7lbs) | 0.9mm (.035") green | 1.5mm (.060") red |
| | 5.5mm / .22cal | 245 m/s (800 fps) | | | | | | |
| | 6.35mm / .25cal | 200 m/s (650 fps) | | | | | | |

(*) Velocity results may vary as much as 20% due to pellet weight, pellet shape, temperature elevation as well as other factors.

Above Maximum muzzle velocity figures may differ depending on the pellet weight & shape.

The energy restrictions of a particular country can be achieved by the reduction in the muzzle velocity.

The above maximum velocity figures are obtained when there is no energy restriction on the air rifle.

1000fps POWER!
with Lead Pellets



Serious. Solid. Impact

AIR TACT

**FULLY SHROUDED
BARREL**



VORTEX
GAS PISTON
Vortex Gas Piston Upgrade Available

Integrated Sound Moderator
Sound moderator in muzzlebreak for reduced down-range noise



VORTEX
GAS PISTON
Vortex Gas Piston Upgrade Available

AIR TACT ED

Integrated Sound Moderator
Sound moderator in muzzlebreak for reduced down-range noise



AIR TACT PD

Unshrouded barrel version with large muzzle break (no sound moderator)



(*) Scope sold separately

| Model | AirTact / AirTact ED / AirTact PD | | |
|------------------------------|---|---------------------|-------------------|
| Caliber | 4.5mm / .177cal | 5.5mm / .22cal | 6.35mm / .25cal |
| Max. Muzzle Velocity (*) | 305 m/s (1000 fps) | 245 m/s (800 fps) | 200 m/s (650 fps) |
| Stock | Advanced Polymer. Integrated Pistol Grip. | | |
| Length | 1135mm (44.7") | | |
| Barrel Length | 370mm (14.5") | | |
| Weight | 2.75kg (6lbs) | | |
| Fiber Optic Sights Diameters | Rear Sight | 0.9mm (.035") green | |
| | Front Sight | 1.5mm (.060") red | |

* Above maximum muzzle velocity figures may differ depending on the pellet weight & shape.

* The energy restrictions of a particular country can be achieved by the reduction in the muzzle velocity. The above maximum velocity figures are obtained when there is no energy restriction on the air rifle.



Serious. Solid. Impact

1000fps POWER!
with Lead Pellets

EDGE



VORTEX
GAS PISTON
Vortex Gas Piston Upgrade Available



EDGE MOONSHINE  **HARVEST MOON**
Harvest moon camouflage version 



EDGE CAMO 
Mossy Oak Break-Up Infinity camo version



EDGE MW
Luxurious walnut woodgrain camo version



| Model | | Edge | | |
|--------------------------|-------------|-----------------------------|-------------------|-------------------|
| Caliber | | 4.5 mm / .177 cal | 5.5 mm / .22 cal | 6.35 mm / .25 cal |
| Max. Muzzle Velocity (*) | | 305 m/s (1000 fps) | 245 m/s (800 fps) | 200 m/s (650 fps) |
| Stock | | Advanced Polymer, Thumbhole | | |
| Length | | 1100mm (43.3") | | |
| Barrel Length | | 420mm (16.5") | | |
| Weight | | 3kg (6.6lbs) | | |
| Fiber Optic | Rear Sight | 0.9mm (.035") green | | |
| Sights Diameters | Front Sight | 1.5mm (.060") red | | |

* Above maximum muzzle velocity figures may differ depending on the pellet weight & shape.

* The energy restrictions of a particular country can be achieved by the reduction in the muzzle velocity. The above maximum velocity figures are obtained when there is no energy restriction on the air rifle.

1000fpsPOWER!
with Lead Pellets



STRIKER 1000S



VORTEX
GAS PISTON
Vortex Gas Piston Upgrade Available



STRIKER 1000S
Dark Grey



STRIKER 1000S
Orange



STRIKER 1000S
Yellow

Soft rubber inlays are available in grey, dark grey,
yellow and orange colors upon request



STRIKER 1000X

VORTEX
GAS PISTON
Vortex Gas Piston Upgrade Available



| Model | | Striker 1000S | | |
|------------------------------|-------------|---|-------------------|-------------------|
| Caliber | | 4.5 mm / .177 cal | 5.5 mm / .22 cal | 6.35 mm / .25 cal |
| Max. Muzzle Velocity (*) | | 305 m/s (1000 fps) | 245 m/s (800 fps) | 200 m/s (650 fps) |
| Stock | | Advanced polymer with montecarlo checkpiece | | |
| Length | | 1095 mm (43") | | |
| Barrel Length | | 420mm (16.5") | | |
| Weight | | 2.9 kg (6.4 lbs) | | |
| Fiber Optic Sights Diameters | Rear Sight | 0.9 mm (.035") green | | |
| | Front Sight | 1.5 mm (.060") red | | |

* Above maximum muzzle velocity figures may differ depending on the pellet weight & shape.

* The energy restrictions of a particular country can be achieved by the reduction in the muzzle velocity. The above maximum velocity figures are obtained when there is no energy restriction on the air rifle.



Serious. Solid. Impact

640fps POWER!
with Lead Pellets

ALPHA

**FULLY SHROUDED
BARREL**



Integrated Sound Moderator
Sound moderator in muzzlebreak for reduced down-range noise



ALPHA CAMO
Mossy Oak Break-Up camo version.



ALPHA MW
Luxurious walnut woodgrain camo version



ALPHA W
Wood stock version.
Unshrouded steel barrel without sound moderator.

| Model | | Alpha | |
|--------------------------|-------------|---------------------|------------------|
| Caliber | | 4.5mm / .177cal | 5.5mm / .22cal |
| Max. Muzzle Velocity (*) | | 195m/s (640 fps) | 170 m/s (550fps) |
| Stock | | Advanced Polymer. | |
| Length | | 1057mm (41.6") | |
| Barrel Length | | 370mm (14.5") | |
| Weight | | 2.3kg (5lbs) | |
| Fiber Optic | Rear Sight | 0.9mm (.035") green | |
| Sights Diameters | Front Sight | 1.5mm (.060") red | |

* Above maximum muzzle velocity figures may differ depending on the pellet weight & shape.

650fpsPOWER!
with Lead Pellets



Serious. Solid. Impact

MOD 35S & MOD 33



MOD 35S



MOD 33



MOD 33 PINK
Mossy Oak Pink camo version.



MOD 33 CAMO
Mossy Oak Break-Up camo version.



MOD 33 MW
Luxurious walnut woodgrain
camo version.

| Model | MOD 33 | MOD 35S |
|---------------------------------|------------------|---------------------|
| Caliber | 4.5mm / .177 cal | 4.5mm / .177 cal |
| Max. Muzzle Velocity (*) | 200m/s (650 fps) | 200m/s (650 fps) |
| Stock | Advanced Polymer | Wooden |
| Length | 1060mm (41.7") | 1070mm (42.1") |
| Barrel Length | 450mm (17.7") | 450mm (17.7") |
| Weight | 3kg (6.6 lbs) | 3kg (6.6 lbs) |
| Fiber Optic Sights Diameters | Rear Sight | 0.9mm (.035") green |
| | Front Sight | 1.5mm (.060") red |
| | | 0.9mm (.035") green |
| | | 1.5mm (.060") red |

* Above maximum muzzle velocity figures may differ depending on the pellet weight & shape.
* The energy restrictions of a particular country can be achieved by the reduction in the muzzle velocity.
The above maximum velocity figures are obtained when there is no energy restriction on the air rifle.



Serious. Solid. Impact

700fps POWER!
with Lead Pellets

SUPER CHARGER QE



QE QuietEnergy Version
QE fully shrouded barrel and Integrated Sound Moderator - Approximately 50% Quieter.



VORTEX
GAS PISTON
Vortex Gas Piston Upgrade Available

XRS - RECOIL REDUCTION SYSTEM

Equipped with Hatsan's "XRS-Recoil Reduction System" for a noticeably smooth shot. Recoil is absorbed during the shot by the design of the sliding action. This makes for a more accurate and comfortable shooting experience.



MOD 25 SUPERCHARGER



VORTEX
GAS PISTON
Vortex Gas Piston Upgrade Available

Mod25 SuperCharger air pistol is designed for high power. It can shoot 700fps. in 177cal (4.5mm) and 600fps in .22cal (5.5mm) all rated with lead pellets. You have the power of an air rifle from the Mod25 SuperCharger air pistol. It's well balanced design fits perfect in your hands. The grip is sporting style and ergonomically shaped. Left hand version grip is available upon request. Muzzle cap fitted muzzle is 1/2" UNF threaded for silencer or muzzle break mounts. The included aluminum cocking aid assists in cocking and also provides a more stylish look.

Aluminum cocking aid.

| Model | Mod 25 SuperCharger | | SuperCharger QE | |
|------------------------------|---------------------|----------------------|-----------------------|-------------------|
| Caliber | 4.5 mm / .177 cal | 5.5 mm / .22 cal | 4.5mm / .177cal | 5.5mm / .22cal |
| Max. Muzzle Velocity (*) | 215 m/s (700 fps) | 180 m/s (600 fps) | 215 m/s (700 fps) | 180 m/s (600 fps) |
| Stock | Advanced Polymer | | Advanced Polymer Grip | |
| Length | 508 mm (20") | | 475 mm (18.7") | |
| Barrel Length | 230 mm (9.05") | | 184 mm (7.2") | |
| Weight | 1.7 kg (3.9 lbs) | | 1.6kg (3.5lbs) | |
| Fiber Optic Sights Diameters | Rear Sight | 0.9 mm (.035") green | 0.9mm (.035") green | |
| | Front Sight | 1.5 mm (.060") red | 1.5mm(.060") red | |

* Above maximum muzzle velocity figures may differ depending on the pellet weight & shape.

* The energy restrictions of a particular country can be achieved by the reduction in the muzzle velocity. The above maximum velocity figures are obtained when there is no energy restriction on the air rifle.

700fps POWER!
with Lead Pellets

QuietEnergy Series



Serious. Solid. Impact

MOD 25 SUPERTACT QE

**FULLY SHROUDED
BARREL**



QuietEnergy Version
QE fully shrouded barrel and
Integrated Sound Moderator -
Approximately 50% Quieter.



**MOD 25
SUPERTACT QE CAMO**



Mossy Oak Break-Up camo version.



**MOD 25
SUPERTACT**



| Model | Mod 25 SuperTact | | Mod 25 SuperTact QE | |
|------------------------------|---|----------------------|---|-------------------|
| Caliber | 4.5 mm / .177 cal | 5.5 mm / .22 cal | 4.5mm / .177cal | 5.5mm / .22cal |
| Max. Muzzle Velocity (*) | 215 m/s (700 fps) | 180 m/s (600 fps) | 215 m/s (700 fps) | 180 m/s (600 fps) |
| Stock | Tactical Telescopic Stock / Advanced Polymer Grip | | Tactical Telescopic Stock / Adjustable Comb / Advanced Polymer Grip | |
| Length | Butt Shortened | 670mm (26.3") | 837mm (32.9") | |
| | Butt Extended | 770mm (30.3") | 937mm (36.9") | |
| Barrel Length | 230mm (9.05") | | 230mm (9") | |
| Weight | 2.5kg (5.5lbs) | | 2.6kg (5.7lbs) | |
| Fiber Optic Sights Diameters | Rear Sight | 0.9 mm (.035") green | 0.9mm (.035") green | |
| | Front Sight | 1.5 mm (.060") red | 1.5mm (.060") red | |

* Above maximum muzzle velocity figures may differ depending on the pellet weight & shape.

* The energy restrictions of a particular country can be achieved by the reduction in the muzzle velocity. The above maximum velocity figures are obtained when there is no energy restriction on the air rifle.



Serious. Solid. Impact

500fpsPOWER!
with Lead Pellets

MOD 25



MOD 25 MW

Luxurious walnut woodgrain
camo version.

Cocking Aid

Easily mounts in the muzzle which
provides an easier cocking.



| Model | MOD 25 | |
|--------------------------|------------------|------------------|
| Caliber | 4.5mm / .177cal | 5.5mm / .22cal |
| Max. Muzzle Velocity (*) | 150m/s (500fps) | 120m/s (400fps) |
| Stock | Advanced Polymer | Advanced Polymer |
| Length | 370mm (14.5") | 370mm (14.5") |
| Barrel Length | 165mm (6.5") | 165mm (6.5") |
| Weight | 1.24kg (2.7 lbs) | 1.24kg (2.7 lbs) |

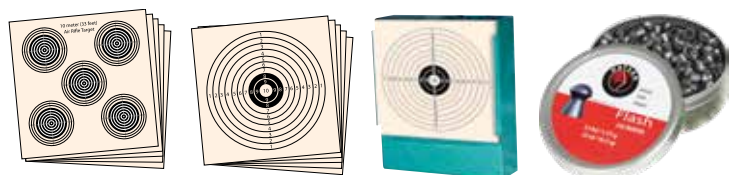

* Above maximum muzzle velocity figures may differ depending on the pellet weight & shape.

* The energy restrictions of a particular country can be achieved by the reduction in the muzzle velocity. The above maximum velocity figures are obtained when there is no energy restriction on the air rifle.



Serious. Solid. Impact



OPTIMA SCOPES



2.5-10x50E SFT Scope
Red illuminated reticle, aluminum frame scope. Comes with scope mounts.



3-12x44AOE Scope
Red illuminated reticle, aluminum frame scope. Comes with scope mounts.



3-9x32 Scope
Aluminum frame scope. Comes with scope mounts.



3-7x20 Scope
Aluminum frame scope. Comes with scope mounts.



4x20 Scope
Aluminum frame scope. Comes with scope mounts.



1x40 Red-Dot Sight
Aluminum frame red dot sight. Comes with integrated mounts.

| Model | Magnification | Objective Diameter | Tube Diameter | Exit Pupil | Eye Relief | Length | Weight |
|---------------------------|---------------|--------------------|---------------|----------------|------------|--------|----------|
| Optima 2.5-10x50E SFT | 2.5x-10x | 50mm | 30mm | 5-20mm | 86-90mm | 322mm | 805grams |
| Optima 1x40 Red Dot Sight | 1X | 40mm | 47mm | 40mm | unlimited | 9.5cm | 190grams |
| Optima 3-12x44AOE Scope | 3X-12X | 44mm | 25.4mm | 14.6 - 3.67mm | 82-87mm | 33cm | 500grams |
| Optima 3-9x32 Scope | 3-9x32 | 32mm | 25.4mm | 3.56 - 10.67mm | 70-85mm | 29.5cm | 395grams |
| Optima 3-7x20 Scope | 3-7x20 | 20mm | 19mm | 6.7 - 2.9mm | 75mm | 29.5cm | 235grams |
| Optima 4x20 Scope | 4x20 | 20mm | 19mm | 5mm | 75mm | 29.5cm | 207grams |



Serious. Solid. Impact

ACCESSORIES



OPTIMA PROTECTOR SCOPE MOUNT

- Eliminates almost all recoil force on the rifle scopes and hence provides repeated accuracy.
- Suitable with 1" (25.4mm) tube diameter rifles scopes.
- Fits 11mm dovetail. 22mm picatinny rail version is available.
- 4 screws per ring secure optics and 3 screws fasten the base of the mount. Includes hex wrench.
- Vertical scope stop pin.
- Dimensions (L x H x W): 120 x 50 x 40mm.
- Weight: 205grams.
- Material: Aluminum.



OPTIMA LONG RANGE SCOPE MOUNT

- Elevation and angle adjustable rings provides more setting needed for long range accuracy.
- 0.16" (4.0mm) elevation adjustable and +/- 1.5 degrees angle adjustable.
- Suitable with 30mm tube diameter rifles scopes.
- Fits 22mm picatinny rails. 11mm dovetail version is available.
- Weight (of 2 rings): 126grams.
- Material: Aluminum.

HATSAN SLING



AIR RIFLE PELLET CATCHER



- Designed to use with Hatsan Air Rifles.
- Special design which traps the pellets and lever lets them out...
- Superb-all-steel construction.
- Galvanized finish assuring durability and total protection against corrosion.
- Comes in its box with 20 pieces Hatsan targets.
- Suitable for shooting with all Hatsan air guns with velocities even up to 1250 fps (375 m/s).
- Intended for use with lead air-gun pellets. Steel BBs should never be used with pellet catchers because of danger of ricochets.

HATSAN AIR RIFLE BAG



Special design air rifle bag fitting all Hatsan air rifles. Made of quality and waterproof material and can carry your air rifle with scope mounted.

AIR PISTOL PELLET CATCHER



HATSAN BIPOD



Designed to use with Hatsan Air Pistol.

HATSAN TARGETS

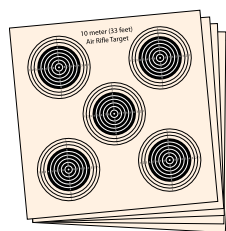

Hatsan Target #1 for short distance shots

- Designed to use with Hatsan pellet catchers.
- Worldwide considered shooting target dimensions. Supplied in 100 pieces packages: 50pcs target #1 & 50pcs target #2

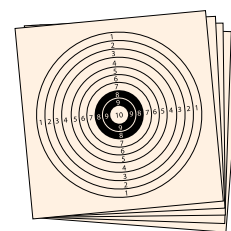

Hatsan Target #2 for long distance shots

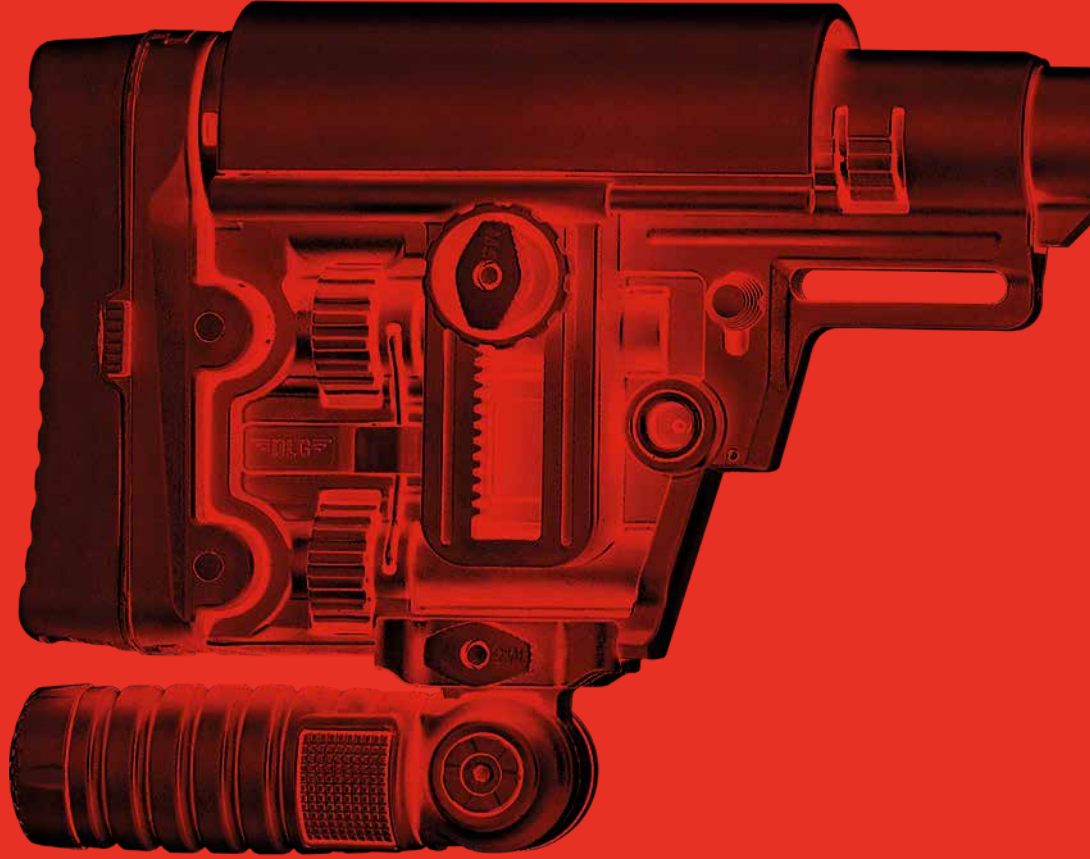

HATSAN ARMS COMPANY

Factory: Kemalpaşa O.S.B. Mahallesi, Anzızca Sanayi Sitesi No: 303,
Kemalpaşa, 35730, İzmir - TURKEY

Office: Kemalpaşa O.S.B. Mahallesi, İzmir - Ankara Karayolu No: 365, İç
Kapi No: 1,

Kemalpaşa, 35730, İzmir - TURKEY

Tel: +90 (232) 878 91 00 Fax: +90 (232) 878 91 02 - 878 97 23

Tel: +90 (232) 878 91 00 Fax: +90 (232) 878 91 02 - 878 97 23

info@hatsan.com.tr

 /hatsanarms  /hatsan  /hatsanarms  /hatsan  /hatsanarms  /hatsan_arms



HATSAN.COM.TR

HATSAN AIRGUNS - 2024